

[www.bradyeurope.com/labid](http://www.bradyeurope.com/labid)

# Laboratory Identification

Labels, printers & software for laboratories



# About BRADY



**Once you have worked with BRADY, our name will stick with you, (just like our labels) because BRADY is one of the world's leading labelling and identification specialists.**

## Innovative

At BRADY we continue to improve. We have many customers from all industries, and we strive to be ahead of their needs by continuing to invest in research for even more performant solutions. By developing more user-friendly and efficient concepts, we give our thousands of customers the best in the market.

## Strength

At BRADY, we believe our biggest strength is the wide range of identification and safety solutions we can offer our customers, whether it's labelling the smallest component or complete signage for an entire warehouse. We're also proud to offer many products and services - from printers, scanners and software to service contracts and on-site training - that compliment any identification job. And don't forget, our wide network of expert distributors can always offer you a tailor-made solution to meet your specific requirements.

## Trust

For over a hundred years, BRADY has been connected with quality, trust and stability. We demand the best for your products and services, because we know, better than anyone, the importance of good and reliable identification. Identification looks like a small detail, but every professional knows that this kind of detail is crucial to any business.

## Inform

We also have specialised dealers in your region, who can answer all your identification and labelling questions, specific to your activity. They will be happy to provide you with all kinds of options and solutions with no obligation.

Microsoft is a trademark of Microsoft Corporation, Bluetooth is a trademark of Bluetooth Sig, Inc., Android is a trademark of Google Inc.



Brady products are sold on the condition that the purchaser will test them in actual use and determine for himself/herself their suitability to his/her intended purpose. Brady warrants to the purchaser that Brady products are free from defects in material and workmanship but limits its obligation under this warranty to the replacement of the product which has been shown to Brady's satisfaction to have been defective at the time of its purchase.

The warranty does not extend to any persons who have acquired the product from the purchaser. It is in lieu of any other warranty, including every warranty of sale-ability, marketability or suitability for the intended purpose, and is also in lieu of any other obligation or liability on the part of Brady.

Under no circumstances will Brady be liable for losses, damage, costs or subsequent damage of whatever nature which may arise in connection with the use of, or inability to use, Brady's products.

# Laboratory Identification

## Labels, printers & software for the laboratory

### TABLE OF CONTENT

Simplify Your Laboratory Identification ..... 4

#### Laboratory Identification Labels

Choose your Application .....	6
Vial / Tube Labels.....	8
Vial Top Labels.....	13
Centrifuge / Microcentrifuge Labels.....	15
Cryo Tubes & Vials .....	18
Conical / Large Tube Labels.....	20
Slide Labels.....	25
Tissue Cassette Labels.....	26
Straw and Rod Labels .....	27
Well Plate Labels .....	28
Bottles / Flasks & Dishes.....	31
Bottle Tamper Seal Labels .....	33
General Lab ID.....	34

#### Label Printers, Label Attachment System and Barcode Scanners

Choose Your Printer.....	38
BMP™21-LAB Label Printer .....	40
BMP™51 Label Maker .....	41
BMP™71 Portable Label Printer.....	42
BBP™12 Label Printer.....	43
BBP™33 Label Printer.....	44
Brady IPT™ Series Printer .....	45
BradyPrinter PR Plus Thermal Transfer Printer.....	46
BSP™31 Label Attachment System.....	47
Label Creation Software .....	48
Scanners for Laboratories.....	49

#### Miscellaneous Products

Hazardous Substance Identification .....	52
Sorbent Products .....	54
Pipemarkers.....	58
Safety Signs on Rolls.....	58

### The Brady Advantage

When it comes to identification, safety and compliance, there's a clear advantage to working with Brady. We put our customers first in everything we do.

Our goal is to give you an unrivalled customer experience. We are relentlessly committed to performance and excellence - in our products, services and people.

Our products and solutions perform in ways that others simply can't match. Our people perform in ways that regularly exceed your expectations, and our focus and discipline work toward solid, long-term performance for our customers.

In short, Brady is the company you trust when performance matters most.

Learn more about the Brady Advantage at: [www.bradyeurope.com](http://www.bradyeurope.com)





# Simplify Your Laboratory Identification

Brady's laboratory identification products are designed to serve the world's biotechnology, agricultural, environmental and forensic researchers. Whether you work in pathology, histology, chromatography or other areas of science, Brady labelling solutions can help you maintain Good Laboratory Practice

## Brady Sample Identification solutions:

- match existing vial, slide, and well plate sizes
- remain legible throughout processing and storage
- endure freezer storage, liquid nitrogen, autoclave, hot water baths and solvents including Xylene, DMSO and Ethanol
- allow bar coding for extensive information storage on even the tiniest sample
- integrate seamlessly with your Laboratory Information Management System (LIMS)

## Hand-written versus printed labels

Did you ever had to postpone research because of unidentified samples, or because nobody was able to read anymore what was once written on the sample you need? Printed laboratory labels, engineered specifically to identify samples, help avoid sample loss and a lot of frustration.



### Hand-Written Information

- Is difficult to read
- Smears when handled
- Has limited communication potential
- Fades over time when stored
- Is erased by chemicals

### Brady Printed Laboratory Labels

- Are crisp, clear and readable
- Do not smear nor fade
- Can hold much information
- Have increased durability
- Resist chemicals

## Lab-durable labels

Brady's special self-laminating or wrap around label protects your label's legend from extreme temperature, chemicals and solvents.

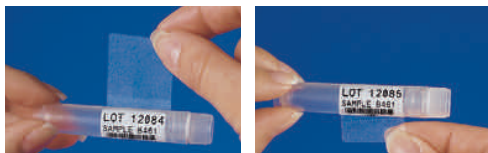

*For best adhesion, we recommend that you do not touch the adhesive side of the label when wrapping it around your vial or tube.*

- Printing is readable every time
- Clear portion wraps around and laminates the legend
- Provides window to view liquid level inside vial
- Low profile (extremely thin) label resists jamming in centrifuge or racks
- Labels withstand liquid nitrogen (-196°C), freezer (-80°C), autoclave (+121°C) and chemicals like Xylene



## On-site Label Creation

Brady printers enable professionals to print highly specialised identification labels on-site and on demand. Partnered with customisable software and a specific application system for laboratories, adaptable to specific processes or data file formats, Brady printers support considerable time savings and flexibility in sample identification.

Every Brady identification label can be printed on-site using a Brady mobile, or benchtop printer. See page 38 for the full range of label printers.

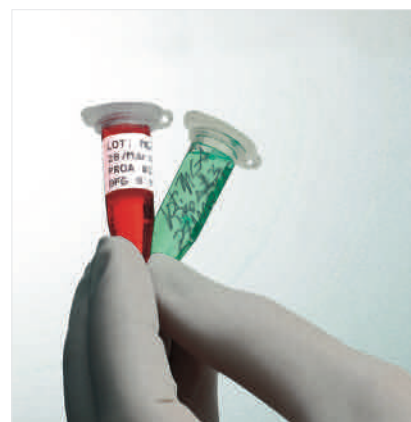
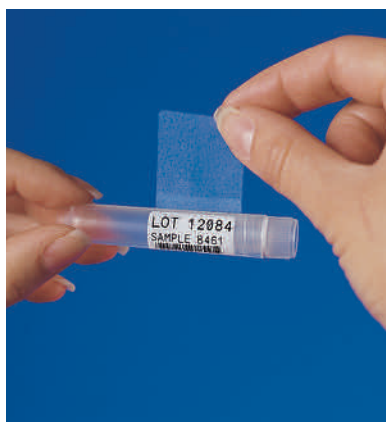

# Laboratory Identification Labels

Extensive material knowledge combined with chemical expertise enables Brady to develop durable labels that perform throughout sample storage and processing.

Choose your Application.....	6
Vial / Tube Labels.....	8
Vial Top Labels.....	13
Centrifuge / Microcentrifuge Labels .....	15
Cryo Tubes & Vials .....	18
Conical / Large Tube Labels .....	20
Slide Labels .....	25
Tissue Cassette Labels .....	26
Straw and Rod Labels.....	27
Well Plate Labels .....	28
Bottles / Flasks & Dishes .....	31
Bottle Tamper Seal Labels.....	33
General Lab ID .....	34

# Choose your Application



Vial/Tube



Conicals/bottles



Slide



Tissue cassette



Straw

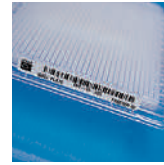

Well Plate



General Lab ID

Material	Printer Ribbon Series	Temp (°C) (Tested for 30 days)		APPLICATION						ENVIRONMENT				OTHER QUALITIES	
				Vial/Tube	Conical / Large Tubes	Slide	Tissue Cassette	Straw	Well Plate	General Lab ID	Freezer	Liquid Nitrogen	Autoclave (121°C)		Hot Water Bath (100°C)
<b>FreezerBondz™ Polyester</b>															
B-490	R4306	-196 °C	130 °C	✓	✓					✓	✓	✓	✓	✓	Retaining perfect integrity and legibility in liquid nitrogen, this ultra thin label avoids jamming in narrow racks and can be applied to already frozen surfaces with a small overlap.
B-492	R6400	-196 °C	130 °C	✓	✓					✓	✓	✓	✓	✓	Retaining perfect integrity and legibility in liquid nitrogen, this ultra resistant label, combined with the R6400 print ribbon, can resist a range of chemicals and can be applied to already frozen surfaces with a small overlap.
<b>Nylon Cloth</b>															
B-499	R4300; R6000; R6200B; R7950	-196 °C	90 °C	✓	✓					✓	✓	✓	✓	✓	Permanent adhesion; write-on capabilities. Temperature range increases to 121°C when used in autoclave process. Tested 3 cycles of 1 hour in 121°C at 15 psi for autoclave process.
<b>Paper</b>															
B-424	R4300; R7950	-80 °C	50 °C							✓	✓				Permanent adhesive; write-on capabilities; good contrast and smear resistance.
<b>Polyester</b>															
B-423	R6000; R4410	-70 °C	120 °C	✓						✓	✓	✓	✓	✓	Permanent acrylic adhesive; ideal for flat surfaces. Suitable to adhering to glass, but not polypropylene.
B-430	R6000	-80 °C	120 °C	✓						✓	✓	✓	✓	✓	Clear polyester with permanent acrylic based adhesive; withstands numerous solvents and can be applied to variable surfaces.
B-432	R6000	-40 °C	100 °C							✓	✓	✓	✓		Clear polyester with permanent acrylic based adhesive; withstands numerous solvents and can be applied to variable surfaces.
B-461	R4300, R7950	-196 °C	130 °C	✓	✓			✓		✓	✓	✓	✓	✓	Permanent adhesive; suitable for liquid nitrogen application if material is wrapped around itself, as in self-lamination; write-on capabilities. Temperature range increases to 121°C when used in autoclave process.
B-482	R6400	-80 °C	130 °C				✓			✓			✓		The B-482 label material, combined with Brady's R6400 ribbon, provides the durability and print quality that histology and anatomic pathology labs need for accurate, identifiable specimen labelling. Paraffin and solvent resistant.
B-488	R4300, R7950	-80 °C	120 °C	✓	✓					✓	✓	✓	✓		Permanent acrylic adhesive; ideal for flat surface; write-on capabilities; excellent solvent resistance and xylene resistance.
B-533	R6000	-70 °C	100 °C							✓	✓	✓			Removable, ideal for flat surfaces. Suitable to adhering to glass, but not polypropylene.
B-8423	R6000	-80 °C	120 °C	✓						✓	✓	✓	✓		Permanent acrylic adhesive; semi-gloss finish; excellent for bar code labels.

>>

# Choose your Application



Vial/Tube



Conicals/bottles



Slide



Tissue cassette



Straw

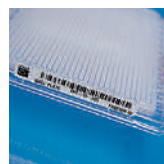

Well Plate



General Lab ID

Material	Printer Ribbon Series	Temp (°C) (Tested for 30 days)		APPLICATION							ENVIRONMENT				OTHER QUALITIES	
				Vial/Tube	Conical / Large Tubes	Slide	Tissue Cassette	Straw	Well Plate	General Lab ID	Freezer	Liquid Nitrogen	Autoclave (121°C)	Hot Water Bath (100°C)	Low-Profile (extremely thin)	Additional Features
<b>Polypropylene</b>																
B-425	R6400	-70 °C	100 °C	✓	✓					✓	✓	✓				Excellent solvent resistance.
B-449	R7961	-80 °C	90 °C	✓	✓						✓		✓			Ideal for temporary labelling applications. Removable from flat surfaces; write-on capabilities; Tested 3 cycles of 1 hour in 121 °C at 15 psi for autoclave process.
B-7425	R4300	-70 °C	80 °C	✓						✓	✓	✓	✓	✓		For freezer or liquid nitrogen applications, B-7425 must be applied prior to being frozen.
<b>StainerBondz™ Polyester</b>																
B-481	R6400	-80 °C	130 °C			✓					✓	✓		✓		White polyester will remain resistant when exposed to xylene and other chemicals that are commonly used in the slide staining process.
<b>Tamper-resistant Vinyl</b>																
B-351	R6200	-80 °C	120 °C							✓	✓	✓				Tamper-evident with a permanent acrylic adhesive; fractures easily to prevent removal.
B-7351	R6210	-40 °C	100 °C							✓	✓	✓				Tamper-evident with a permanent acrylic adhesive; fractures easily to prevent removal.
<b>Vinyl</b>																
B-427	R4300	-80 °C	70 °C	✓	✓			✓			✓	✓				Permanent acrylic adhesive; self-laminating; write-on capabilities; suitable for liquid nitrogen application and can be used to identify a frozen vial if label material is wrapped around itself, as in self-lamination. Temperature range goes to -196°C if material is wrapped around vial and overlaps itself.
B-595	R6000; R4400; R6900	-40 °C	82 °C							✓	✓	✓				Available in White, Red, Yellow, Green, Blue, Orange, Black and Clear.
<b>Vinyl Cloth</b>																
B-498	R4300	-40 °C	80 °C	✓	✓	✓				✓	✓	✓				Removable from flat surfaces; write-on capabilities. Available in White.



## Part number explanation

Most Brady references for printable labels follow the same three-part format: The first code indicates the technology, the second part is a number indicating the label size (where applicable) and the third part indicates the Brady material (where applicable).

# M71-73-461

BMP71  
Technology

Label size  
code

Material  
(B-number)



## VIAL / TUBE LABELS

Brady's vial and test tube labels are designed to withstand extreme laboratory solvents like Xylene, Ethanol, Alcohol and DMSO, ensuring that the specimen identification is always legible - and will not smear, fade or fall off.

- F** Freezer environment
- N** Liquid nitrogen environment
- A** Autoclave environment
- H** Hot water bath (100°C)
- S** Self-laminating label
- L** Low-profile (extremely thin) label
- R** Removable

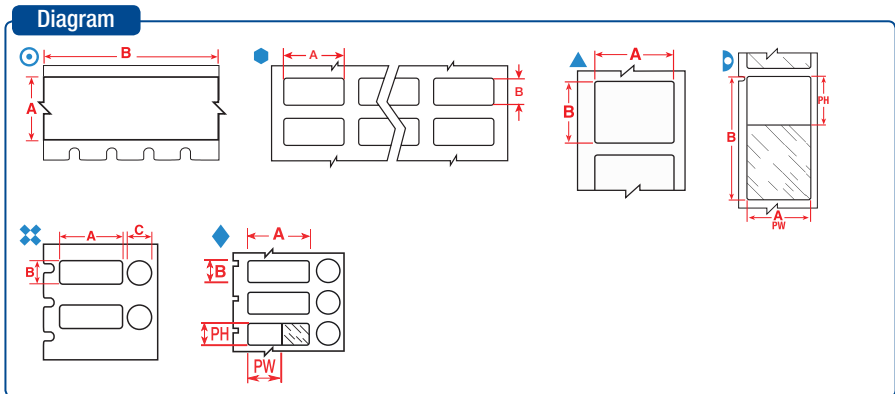

Labels are shown per vial / tube size and in order of label width.

The background colours in the Order Reference column represent the material colour.

See page 38 for Brady's range of label printers.

Diagram	Material	Special Properties	Label Width A (mm)	Label Height B (mm)	Label Length B (m)	Diameter C (mm)	Printable Area Width PW (mm)	Printable Area Height PH (mm)	Order Reference	Printer Compatibility	Printer Ribbon Series	Labels/Package	Labels per Row
<b>0.5 ml</b>													
⊙	B-423	<b>F A H</b>	6.35	-	6.40	-	-	-	M21-250-423	BMP21-LAB	-	1	1
<b>0.5 - 0.7 ml</b>													
▷	B-461	<b>F N A H S L</b>	9.53	45.72	-	-	9.53	19.05	M71-73-461	BMP71	M71-R6200	250	1
⬢	B-490	<b>F N H L</b>	12.70	19.05	-	-	-	-	B33-68-490	BBP33	B30-R4300	2500	4
⬢	B-498	<b>F R</b>	12.70	19.05	-	-	-	-	B33-68-498	BBP33	B30-R6200	5000	4
⬢	B-499	<b>F N A</b>	12.70	19.05	-	-	-	-	B33-68-499	BBP33	B30-R6000HF	1500	4
⬢	B-498	<b>F R</b>	12.70	19.05	-	-	-	-	THT-68-498-10	BBP12, BP-PR+, IP	R4300, R7950	10000	4
⬢	B-499	<b>F N A</b>	12.70	19.05	-	-	-	-	THT-68-499-10	BBP12, BP-PR+, IP	R4900	10000	4
▲	B-499	<b>F N A</b>	12.70	25.40	-	-	-	-	B33-620-499	BBP33	B30-R6000HF	1000	1
▲	B-499	<b>F N A</b>	12.70	25.40	-	-	-	-	BPT-620-499	BBP12, BP-PR+	R7950	1000	1
▷	B-461	<b>F N A H S L</b>	12.70	55.88	-	-	12.70	19.05	B33-127-461	BBP33	B30-R4300	1500	3
▷	B-427	<b>F N S</b>	12.70	55.88	-	-	12.70	19.05	THT-127-427-3*	BBP12, BP-PR+, IP	R4300, R7950	3000	1
▷	B-461	<b>F N A H S L</b>	12.70	55.88	-	-	12.70	19.05	THT-127-461-3*	BBP12, BP-PR+, IP	R4300, R7950	3000	1
▷	B-461	<b>F N A H S L</b>	12.70	55.88	-	-	12.70	19.05	THT-127-461-1.5-SC*	BBP12, BP-PR+	R7950	1500	1
▲	B-498	<b>F R</b>	19.05	12.70	-	-	-	-	BM71-11-498	BMP71	M71-R6200	5000	1
▲	B-498	<b>F R</b>	19.05	12.70	-	-	-	-	M71-11-498	BMP71	M71-R6200	500	1
⬢	B-492	<b>F N H L</b>	25.40	9.53	-	-	-	-	B33-152-492	BBP33	B30-R6400	2500	2
⬢	B-499	<b>F N A</b>	25.40	9.53	-	-	-	-	B33-152-499	BBP33	B30-R6000HF	1500	2
▲	B-492	<b>F N H L</b>	25.40	9.53	-	-	-	-	M71-16-492	BMP71	M71-R6400	500	1
⊘	B-499	<b>F A</b>	25.40	9.53	-	9.53	-	-	M71-98-499	BMP71	M71-R4300	500	1
⬢	B-492	<b>F N H L</b>	25.40	9.53	-	-	-	-	THT-152-492-3	BBP12, BP-PR+, IP	R6400	3000	2
⬢	B-499	<b>F N A</b>	25.40	9.53	-	-	-	-	THT-152-499-3	BBP12, BP-PR+, IP	R4900	3000	2
▲	B-492	<b>F N H L</b>	25.40	9.53	-	-	-	-	THT-152-492-2.5-SC	BBP12, BP-PR+	R6400	2500	2
⬢	B-499	<b>F N A</b>	25.40	9.53	-	-	-	-	THT-152-499-1.5-SC	BBP12, BP-PR+	R7950	1500	2
◆	B-461	<b>F A H S L</b>	25.40	9.53	-	9.53	20.00	9.53	BPT-606-461	BBP12, BP-PR+	R7950	1000	1
⬢	B-425	<b>F</b>	25.40	9.98	-	-	-	-	THT-30-425-10	BBP12, BP-PR+, IP	R6400	10000	3

\*Label is rotated 90° on liner.

>>

**F** Freezer environment **N** Liquid nitrogen environment **A** Autoclave environment **H** Hot water bath (100°C) **S** Self-laminating label **L** Low-profile (extremely thin) label **R** Removable



## Diagram

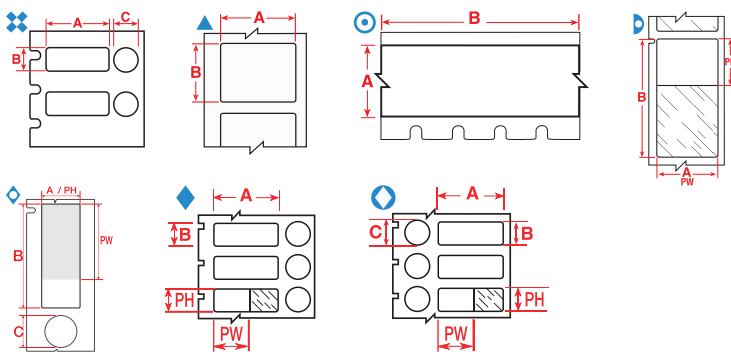

Labels are shown per vial / tube size and in order of label width.

The background colours in the Order Reference column represent the material colour.

See page 38 for Brady's range of label printers.

Diagram	Material	Special Properties	Label Width A (mm)	Label Height B (mm)	Label Length B (m)	Diameter C (mm)	Printable Area Width PW (mm)	Printable Area Height PH (mm)	Order Reference	Printer Compatibility	Printer Ribbon Series	Labels/Package	Labels per Row
<b>0.5 - 8.0 ml</b>													
❖	B-492	<b>F H L</b>	25.40	9.53	-	9.53	-	-	THT-249-492-1.5-SC	BBP12, BP-PR+	R6400	1500	1
❖	B-499	<b>F A</b>	25.40	9.53	-	9.53	-	-	THT-249-499-1.5-SC	BBP12, BP-PR+	R7950	1500	1
❖	B-492	<b>F H L</b>	25.40	12.70	-	11.18	-	-	THT-251-492-1.5-SC	BBP12, BP-PR+	R6400	1500	1
❖	B-492	<b>F H L</b>	25.40	12.70	-	9.53	-	-	THT-250-492-1.5-SC	BBP12, BP-PR+	R6400	1500	1
<b>0.6 ml</b>													
⊙	B-499	<b>F N A</b>	9.53	-	4.88	-	-	-	M21-375-499	BMP21-LAB	-	1	1
⊙	B-499	<b>F N A</b>	9.53	-	4.88	-	-	-	MC-375-499	BMP51, BMP53	-	1	1
⊙	B-7425	<b>F N A H</b>	9.53	-	6.40	-	-	-	M21-375-7425	BMP21-LAB	-	1	1
⊙	B-461	<b>F N A H S L</b>	9.53	-	6.40	-	9.53	-	M21-375-461-AW**	BMP21-LAB	-	1	1
▲	B-490	<b>F N H L</b>	22.86	12.70	-	-	-	-	B33-125-490	BBP33	B30-R4300	1650	1
▲	B-499	<b>F N A</b>	22.86	12.70	-	-	-	-	B33-125-499	BBP33	B30-R6000HF	1500	1
▲	B-499	<b>F N A</b>	22.86	12.70	-	-	-	-	M71-84-499	BMP71	M71-R4300	500	1
▲	B-499	<b>F N A</b>	22.86	12.70	-	-	-	-	THT-125-499-3	BBP12, BP-PR+, IP	R4900	3000	1
▲	B-499	<b>F N A</b>	22.86	12.70	-	-	-	-	THT-125-499-1.5-SC	BBP12, BP-PR+	R7950	1500	1
<b>1.0 - 2.0 ml</b>													
▷	B-461	<b>F N A H S L</b>	15.00	40.00	-	-	15.00	30.00	BPTLAB-21-461-2.5	BBP12, BP-PR+	R7950	2500	1
▷	B-461	<b>F N A H S L</b>	15.24	38.10	-	-	15.24	33.00	BPT-628-461*	BBP12, BP-PR+	R7950	2500	2
▷	B-461	<b>F N A H S L</b>	15.24	38.10	-	-	15.24	33.00	M71-100-461	BMP71	M71-R6200	500	1
▷	B-461	<b>F N A H S L</b>	15.24	38.10	-	-	15.24	33.03	B33-628-461*	BBP33	B30-R4300	2500	2
◇	B-461	<b>F A H S L</b>	15.24	41.28	-	12.70	15.24	30.00	M71-116-461	BMP71	M71-R6200	150	1
▷	B-461	<b>F N A H S L</b>	15.24	66.68	-	-	15.24	25.40	B33-612-461	BBP33	B30-R4300	1500	3
▷	B-461	<b>F N A H S L</b>	15.24	66.68	-	-	15.24	25.40	BPT-612-461	BBP12, BP-PR+	R7950	1500	3
❖	B-492	<b>F H L</b>	25.40	9.53	-	9.53	-	-	B33-163-492	BBP33	B30-R6400	1500	1
❖	B-499	<b>F A</b>	25.40	9.53	-	9.53	-	-	B33-163-499	BBP33	B30-R6000HF	1500	1
❖	B-492	<b>F H L</b>	25.40	9.53	-	9.53	-	-	THT-163-492-3	BBP12, BP-PR+, IP	R6400	3000	1
❖	B-499	<b>F A</b>	25.40	9.53	-	9.53	-	-	THT-163-499-3	BBP12, BP-PR+, IP	R4900	3000	1
❖	B-492	<b>F H L</b>	25.40	12.70	-	9.53	-	-	B33-181-492	BBP33	B30-R6400	1500	1
❖	B-492	<b>F H L</b>	25.40	12.70	-	11.18	-	-	B33-182-492	BBP33	B30-R6400	1500	1
❖	B-492	<b>F H L</b>	25.40	12.70	-	9.53	-	-	M71-118-492	BMP71	M71-R6400	500	1
❖	B-492	<b>F H L</b>	25.40	12.70	-	11.18	-	-	THT-182-492-3	BBP12, BP-PR+, IP	R6400	3000	1
❖	B-492	<b>F H L</b>	25.40	12.70	-	9.53	-	-	THT-181-492-3	BBP12, BP-PR+, IP	R6400	3000	1
▷	B-461	<b>F N A H S L</b>	25.40	44.45	-	-	25.40	25.40	B33-183-461	BBP33	B30-R4300	2000	1
▷	B-461	<b>F N A H S L</b>	25.40	44.45	-	-	25.40	25.40	M71-106-461	BMP71	M71-R6200	250	1
▷	B-461	<b>F N A H S L</b>	25.40	44.45	-	-	25.40	25.40	THT-183-461-1	BBP12, BP-PR+, IP	R4300, R7950	1000	1
◇	B-461	<b>F A H S L</b>	40.00	15.00	-	9.00	30.00	15.00	BPTLAB-20-461-2.5	BBP12, BP-PR+	R7950	2500	1
◇	B-461	<b>F A H S L</b>	40.00	15.00	-	9.53	30.00	15.00	M71-101-461	BMP71	M71-R6200	250	1
❖	B-499	<b>F A</b>	41.28	15.24	-	12.70	-	-	BPT-608-499	BBP12, BP-PR+	R7950	1000	1
⊙	B-461	<b>F A H S L</b>	41.28	15.24	-	12.70	30.00	15.24	B33-608-461	BBP33	B30-R4300	1000	1
◇	B-461	<b>F A H S L</b>	41.28	15.24	-	12.70	30.00	15.24	BPT-608-461	BBP12, BP-PR+	R7950	1000	1

\*Label is rotated 90° on liner.

\*\*AW = All White / no transparent area.

>>

**F** Freezer environment **N** Liquid nitrogen environment **A** Autoclave environment **H** Hot water bath (100°C) **S** Self-laminating label **L** Low-profile (extremely thin) label **R** Removable

# Vial / Tube Labels

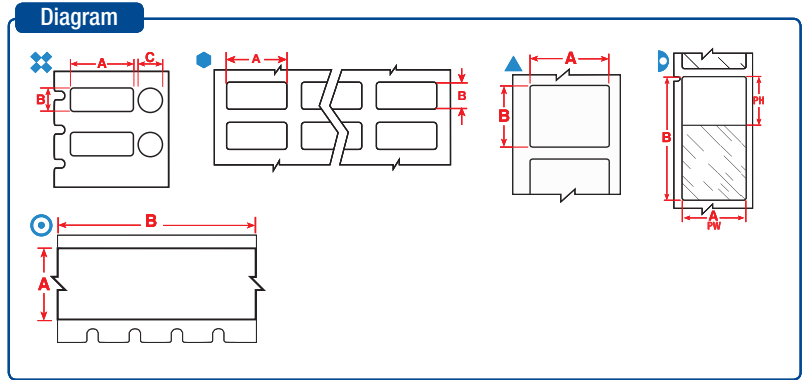

Labels are shown per vial / tube size and in order of label width.

The background colours in the Order Reference column represent the material colour.

See page 38 for Brady's range of label printers.

Diagram	Material	Special Properties	Label Width A (mm)	Label Height B (mm)	Label Length B (m)	Diameter C (mm)	Printable Area Width PW (mm)	Printable Area Height PH (mm)	Order Reference	Printer Compatibility	Printer Ribbon Series	Labels/Package	Labels per Row
<b>1.0 - 8.0 ml</b>													
▷	B-461	<b>F N A H S L</b>	15.24	41.28	-	-	15.24	25.40	M71-76-461	BMP71	M71-R6200	500	1
▷	B-461	<b>F N A H S L</b>	15.24	66.68	-	-	15.24	25.40	B33-153-461*	BBP33	B30-R4300	1500	1
▷	B-461	<b>F N A H S L</b>	15.24	66.68	-	-	15.24	25.40	M71-86-461	BMP71	M71-R6200	100	1
●	B-498	<b>F</b> <b>R</b>	19.05	23.80	-	-	-	-	B33-91-498	BBP33	B30-R6200	2500	4
●	B-498	<b>F</b> <b>R</b>	19.05	23.80	-	-	-	-	THT-91-498-5	BBP12, BP-PR+, IP	R4300, R7950	5000	4
⊗	B-490	<b>F</b> <b>H</b> <b>L</b>	22.86	12.70	-	12.70	-	-	B33-126-490	BBP33	B30-R4300	2500	1
⊗	B-499	<b>F</b> <b>A</b>	22.86	12.70	-	12.70	-	-	M71-126-499	BMP71	M71-R4300	500	1
⊗	B-499	<b>F</b> <b>A</b>	22.86	12.70	-	12.70	-	-	THT-126-499-3	BBP12, BP-PR+, IP	R4900	3000	1
●	B-498	<b>F</b> <b>R</b>	25.40	19.05	-	-	-	-	B33-88-498	BBP33	B30-R6200	2500	2
▲	B-498	<b>F</b> <b>R</b>	25.40	19.05	-	-	-	-	BM71-18-498	BMP71	M71-R6200	2500	1
▲	B-498	<b>F</b> <b>R</b>	25.40	19.05	-	-	-	-	M-48-498	BMP51, BMP53	-	180	1
▲	B-498	<b>F</b> <b>R</b>	25.40	19.05	-	-	-	-	M71-18-498	BMP71	M71-R6200	250	1
▲	B-499	<b>F N A</b>	25.40	19.05	-	-	-	-	M71-18-499	BMP71	M71-R4300	250	1
●	B-492	<b>F N</b> <b>H</b> <b>L</b>	25.40	19.05	-	-	-	-	THT-88-492-5	BBP12, BP-PR+, IP	R6400	5000	2
●	B-498	<b>F</b> <b>R</b>	25.40	19.05	-	-	-	-	THT-88-498-5	BBP12, BP-PR+, IP	R4300, R7950	5000	2
▲	B-492	<b>F N</b> <b>H</b> <b>L</b>	25.40	19.05	-	-	-	-	THT-88-492-2.5-SC	BBP12, BP-PR+	R6400	2500	2
▷	B-461	<b>F N A H S L</b>	25.40	66.68	-	-	25.40	25.40	M71-115-461	BMP71	M71-R6200	100	1
▷	B-427	<b>F N</b> <b>S</b>	25.40	66.68	-	-	25.40	25.40	THT-131-427-3*	BBP12, BP-PR+, IP	R4300, R7950	3000	1
▷	B-461	<b>F N A H S L</b>	25.40	66.68	-	-	25.40	25.40	THT-131-461-3*	BBP12, BP-PR+, IP	R4300, R7950	3000	1
▷	B-461	<b>F N A H S L</b>	25.40	66.68	-	-	25.40	25.40	THT-131-461-1.5-SC*	BBP12, BP-PR+	R7950	1500	1
▲	B-490	<b>F N</b> <b>H</b> <b>L</b>	41.28	15.24	-	-	-	-	B33-155-490	BBP33	B30-R4300	1500	1
▲	B-492	<b>F N</b> <b>H</b> <b>L</b>	41.28	15.24	-	-	-	-	B33-155-492	BBP33	R6400	1500	1
⊗	B-492	<b>F</b> <b>H</b> <b>L</b>	41.28	15.24	-	9.53	-	-	B33-190-492	BBP33	R6400	1500	1
▲	B-490	<b>F N</b> <b>H</b> <b>L</b>	41.28	15.24	-	-	-	-	M71-76-490	BMP71	M71-R4300	500	1
⊗	B-492	<b>F</b> <b>H</b> <b>L</b>	41.28	15.24	-	9.53	-	-	THT-190-492-3	BBP12, BP-PR+, IP	R6400	3000	1
▲	B-490	<b>F N</b> <b>H</b> <b>L</b>	41.28	15.24	-	-	-	-	THT-155-490-3	BBP12, BP-PR+, IP	R4300, R7950	3000	1
▲	B-492	<b>F N</b> <b>H</b> <b>L</b>	41.28	15.24	-	-	-	-	THT-155-492-3	BBP12, BP-PR+, IP	R6400	3000	1
▲	B-490	<b>F N</b> <b>H</b> <b>L</b>	41.28	15.24	-	-	-	-	THT-155-490-1.5-SC	BBP12, BP-PR+	R7950	1500	1
▲	B-492	<b>F N</b> <b>H</b> <b>L</b>	44.45	25.40	-	-	-	-	M-125-492	BMP51, BMP53	-	180	1
▲	B-490	<b>F N</b> <b>H</b> <b>L</b>	48.26	25.40	-	-	-	-	B33-156-490	BBP33	B30-R4300	1500	1
▲	B-492	<b>F N</b> <b>H</b> <b>L</b>	48.26	25.40	-	-	-	-	B33-156-492	BBP33	B30-R6400	1500	1
▲	B-492	<b>F N</b> <b>H</b> <b>L</b>	48.26	25.40	-	-	-	-	M71-78-492	BMP71	M71-R6400	250	1
▲	B-490	<b>F N</b> <b>H</b> <b>L</b>	48.26	25.40	-	-	-	-	THT-156-490-3	BBP12, BP-PR+, IP	R4300, R7950	3000	1
▲	B-492	<b>F N</b> <b>H</b> <b>L</b>	48.26	25.40	-	-	-	-	THT-156-492-3	BBP12, BP-PR+, IP	R6400	3000	1
▲	B-490	<b>F N</b> <b>H</b> <b>L</b>	48.26	25.40	-	-	-	-	THT-156-490-1.5-SC	BBP12, BP-PR+	R7950	1500	1
▲	B-492	<b>F N</b> <b>H</b> <b>L</b>	48.26	25.40	-	-	-	-	THT-156-492-1.5-SC	BBP12, BP-PR+	R6400	1500	1
▷	B-427	<b>F N</b> <b>S</b>	66.68	25.40	-	-	25.40	25.40	B33-131-427	BBP33	B30-R4300	1500	1
<b>1.5 ml</b>													
○	B-499	<b>F N A</b>	12.70	-	4.88	-	-	-	M21-500-499	BMP21-LAB	-	1	1
○	B-499	<b>F N A</b>	12.70	-	4.88	-	-	-	MC-500-499	BMP51, BMP53	-	1	1
○	B-7425	<b>F N A H</b>	12.70	-	6.40	-	-	-	M21-500-7425	BMP21-LAB	-	1	1
○	B-461	<b>F N A H S L</b>	12.70	-	6.40	-	12.70	-	M21-500-461-AW**	BMP21-LAB	-	1	1
○	B-499	<b>F N A</b>	12.70	-	9.10	-	-	-	M71C-500-499	BMP71	M71-R4300	1	1

\*Label is rotated 90° on liner. \*\*AW = All White / no transparent area.

>>>

**F** Freezer environment **N** Liquid nitrogen environment **A** Autoclave environment **H** Hot water bath (100°C) **S** Self-laminating label **L** Low-profile (extremely thin) label **R** Removable

## Diagram

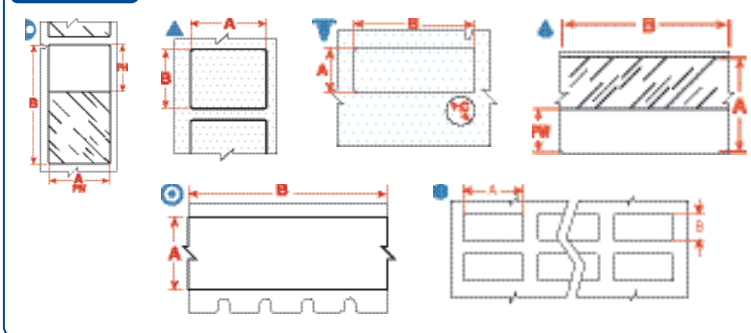

Labels are shown per vial / tube size and in order of label width.

The background colours in the Order Reference column represent the material colour.

See page 38 for Brady's range of label printers.

Diagram	Material	Special Properties	Label Width A (mm)	Label Height B (mm)	Label Length B (m)	Diameter C (mm)	Printable Area Width PW (mm)	Printable Area Height PH (mm)	Order Reference	Printer Compatibility	Printer Ribbon Series	Labels/Package	Labels per Row
<b>1.5 - 2.0 ml</b>													
	B-461	<b>FNAHSL</b>	15.24	41.28	-	-	15.24	25.40	B33-133-461	BBP33	B30-R4300	1500	3
	B-461	<b>FNAHSL</b>	15.24	41.28	-	-	15.24	25.40	THT-133-461-3*	BBP12, BP-PR+, IP	R4300, R7950	3000	1
	B-461	<b>FNAHSL</b>	15.24	41.28	-	-	15.24	25.40	THT-133-461-1.5-SC*	BBP12, BP-PR+	R7950	1500	1
	B-461	<b>FNAHSL</b>	15.24	66.68	-	-	15.24	25.40	THT-153-461-3*	BBP12, BP-PR+, IP	R4300, R7950	3000	1
	B-461	<b>FNAHSL</b>	15.24	66.68	-	-	15.24	25.40	THT-153-461-1.5-SC*	BBP12, BP-PR+	R7950	1500	1
	B-492	<b>FNHL</b>	25.40	12.70	-	-	-	-	B33-59-492	BBP33	B30-R6400	2500	1
	B-492	<b>FNHL</b>	25.40	12.70	-	-	-	-	THT-59-492-10	BBP12, BP-PR+, IP	R6400	10000	1
	B-492	<b>FNHL</b>	25.40	12.70	-	-	-	-	THT-59-492-2.5-SC	BBP12, BP-PR+	R6400	2500	1
	B-492	<b>FHL</b>	41.28	15.24	-	9.53	-	-	M-95-492	BMP51, BMP53	-	200	1
	B-492	<b>FNHL</b>	41.91	12.70	-	-	-	-	M-124-492	BMP51, BMP53	-	180	1
<b>2.0 - 4.0 ml</b>													
	B-461	<b>FNAHSL</b>	15.24	48.26	-	-	15.24	40.00	B33-638-461*	BBP33	B30-R4300	2000	1
	B-461	<b>FNAHSL</b>	15.24	48.26	-	-	15.24	40.00	BPT-638-461*	BBP12, BP-PR+	R7950	2000	1
	B-461	<b>FNAHSL</b>	15.24	48.26	-	-	15.24	40.00	M71-119-461	BMP71	M71-R6200	500	1
<b>2.0 - 50.0 ml</b>													
	B-427	<b>FN S</b>	19.05	-	4.30	-	9.53	-	M21-750-427	BMP21-LAB	-	1	-
	B-499	<b>FNA</b>	19.05	-	4.88	-	-	-	M21-750-499	BMP21-LAB	-	1	1
	B-499	<b>FNA</b>	19.05	-	4.88	-	-	-	MC-750-499	BMP51, BMP53	-	1	1
	B-7425	<b>FNAH</b>	19.05	-	6.40	-	-	-	M21-750-7425	BMP21-LAB	-	1	1
	B-461	<b>FNAHSL</b>	19.05	-	6.40	-	19.05	-	M21-750-461-AW**	BMP21-LAB	-	1	1
	B-427	<b>FN S</b>	19.05	-	7.62	-	9.53	-	MC-750-427	BMP51, BMP53	-	1	1
	B-499	<b>FNA</b>	25.40	-	4.88	-	-	-	MC-1000-499	BMP51, BMP53	-	1	1
	B-499	<b>FNA</b>	25.40	-	9.10	-	-	-	M71C-1000-499	BMP71	M71-R4300	1	1
<b>4.0 - 8.0 ml</b>													
	B-499	<b>FNA</b>	25.40	66.68	-	-	-	-	B33-625-499	BBP33	B30-R6000HF	1500	3
	B-499	<b>FNA</b>	25.40	66.68	-	-	-	-	BPT-625-499	BBP12, BP-PR+	R7950	1500	3
<b>4.0 - 50.0 ml</b>													
	B-461	<b>FNAHSL</b>	34.93	45.72	-	-	34.93	40.00	B33-632-461*	BBP33	B30-R4300	1500	1
	B-461	<b>FNAHSL</b>	34.93	45.72	-	-	34.93	40.00	BPT-632-461*	BBP12, BP-PR+	R7950	2000	1
<b>5.0 - 50.0 ml</b>													
	B-499	<b>FNA</b>	48.26	-	9.10	-	-	-	M71C-1900-499	BMP71	M71-R4300	1	1
<b>12.0 - 24.0 ml</b>													
	B-498	<b>F R</b>	12.70	36.50	-	-	-	-	B33-87-498	BBP33	B30-R6200	2500	6
	B-498	<b>F R</b>	12.70	36.50	-	-	-	-	THT-87-498-5	BBP12, BP-PR+, IP	R4300, R7950	5000	6
<b>12.0 - 50.0 ml</b>													
	B-461	<b>FNAHSL</b>	25.40	133.35	-	-	25.40	38.10	B33-139-461	BBP33	B30-R4300	650	2
	B-461	<b>FNAHSL</b>	25.40	133.35	-	-	25.40	38.10	THT-139-461-2	BBP12, BP-PR+, IP	R4300, R7950	2000	2
<b>14.0 - 15.0 ml</b>													
	B-490	<b>FNHL</b>	55.88	38.10	-	-	-	-	THT-157-490-3	BBP12, BP-PR+, IP	R4300, R7950	3000	1
	B-490	<b>FNHL</b>	55.88	38.10	-	-	-	-	THT-157-490-1.5-SC	BBP12, BP-PR+	R7950	1500	1

\*Label is rotated 90° on liner. \*\*AW = All White / no transparent area.

>>

**F** Freezer environment **N** Liquid nitrogen environment **A** Autoclave environment **H** Hot water bath (100°C) **S** Self-laminating label **L** Low-profile (extremely thin) label **R** Removable

# Vial / Tube Labels

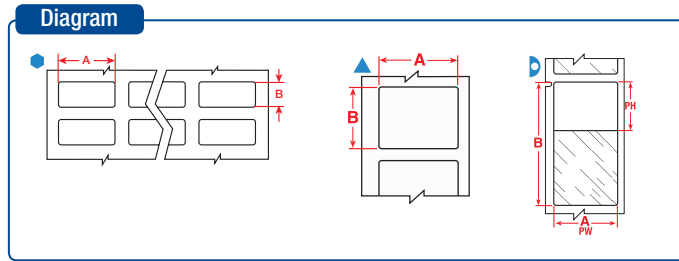

Labels are shown per vial / tube size and in order of label width.

The background colours in the Order Reference column represent the material colour.

See page 38 for Brady's range of label printers.

Diagram	Material	Special Properties	Label Width A (mm)	Label Height B (mm)	Label Length B (m)	Diameter C (mm)	Printable Area Width PW (mm)	Printable Area Height PH (mm)	Order Reference	Printer Compatibility	Printer Ribbon Series	Labels/Package	Labels per Row
<b>15.0 - 50.0 ml</b>													
⬡	B-499	<b>F N A</b>	12.70	25.40	-	-	-	-	B33-611-499	BBP33	B30-R6000HF	3000	3
⬡	B-498	<b>F</b> <b>R</b>	12.70	25.40	-	-	-	-	BPT-611-498	BBP12, BP-PR+	R7950	3000	3
⬡	B-499	<b>F N A</b>	12.70	25.40	-	-	-	-	BPT-611-499	BBP12, BP-PR+	R7950	3000	3
⬡	B-499	<b>F N A</b>	25.40	12.40	-	-	-	-	B33-659-499	BBP33	B30-R6000HF	1000	1
⬡	B-498	<b>F</b> <b>R</b>	25.40	12.40	-	-	-	-	BPT-659-498	BBP12, BP-PR+	R7950	1000	1
⬡	B-499	<b>F N A</b>	25.40	12.40	-	-	-	-	BPT-659-499	BBP12, BP-PR+	R7950	1000	1
⬡	B-499	<b>F N A</b>	25.40	36.50	-	-	-	-	B33-621-499	BBP33	B30-R6000HF	3000	3
⬡	B-498	<b>F</b> <b>R</b>	25.40	36.50	-	-	-	-	B33-89-498	BBP33	B30-R6200	2300	3
⬡	B-499	<b>F N A</b>	25.40	36.50	-	-	-	-	BPT-621-499	BBP12, BP-PR+	R7950	3000	3
⬡	B-461	<b>F N A H S L</b>	25.40	66.68	-	-	25.40	25.40	B33-276-461	BBP33	B30-R4300	1500	2
⬡	B-461	<b>F N A H S L</b>	38.10	88.90	-	-	38.10	31.75	B33-134-461*	BBP33	B30-R4300	1000	1
⬡	B-461	<b>F N A H S L</b>	38.10	88.90	-	-	38.10	31.75	THT-134-461-3*	BBP12, BP-PR+, IP	R4300, R7950	3000	1
<b>50.0 ml</b>													
⬡	B-492	<b>F N H L</b>	22.86	25.40	-	-	-	-	B33-180-492	BBP33	B30-R6400	1500	1
⬡	B-492	<b>F N H L</b>	22.86	25.40	-	-	-	-	THT-180-492-3	BBP12, BP-PR+, IP	R6400	3000	1
⬡	B-425	<b>F</b>	25.40	12.70	-	-	-	-	B33-5-425	BBP33	B30-R4300	5000	3
⬡	B-498	<b>F</b> <b>R</b>	25.40	12.70	-	-	-	-	B33-5-498	BBP33	B30-R6200	5000	3
⬡	B-425	<b>F</b>	25.40	12.70	-	-	-	-	THT-5-425-10	BBP12, BP-PR+, IP	R6400	10000	3
⬡	B-492	<b>F N H L</b>	25.40	25.40	-	-	-	-	B33-179-492	BBP33	B30-R6400	1900	1
⬡	B-492	<b>F N H L</b>	25.40	25.40	-	-	-	-	THT-179-492-3	BBP12, BP-PR+, IP	R6400	3000	1
⬡	B-492	<b>F N H L</b>	25.40	25.40	-	-	-	-	THT-179-492-2.5-SC	BBP12, BP-PR+	R6400	2500	1
⬡	B-490	<b>F N H L</b>	50.80	6.35	-	-	-	-	B33-151-490	BBP33	B30-R4300	2500	1
<b>50.0 ml</b>													
⬡	B-499	<b>F N A</b>	25.40	63.50	-	-	-	-	M71-21-499	BMP71	M71-R4300	100	1

\*Label is rotated 90° on liner.



## Vial and Tube ID

"Brady helps the world's largest HIV research network develop more efficient, more accurate laboratory labelling protocols.

*Adult Clinical Trials Group*



**F** Freezer environment **N** Liquid nitrogen environment **A** Autoclave environment **H** Hot water bath (100°C) **S** Self-laminating label **L** Low-profile (extremely thin) label **R** Removable



## VIAL TOP LABELS

Save time by using the Vial and Vial top combination labels - print your information in one go.

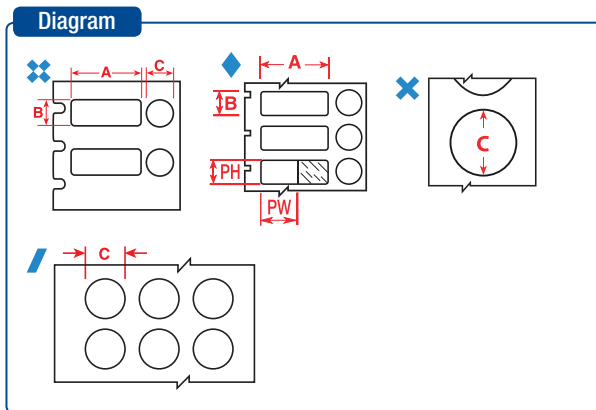

- F** Freezer environment
- A** Autoclave environment
- H** Hot water bath (100°C)
- S** Self-laminating label
- L** Low-profile (extremely thin) label
- R** Removable

Labels are shown per vial / tube size and in order of label width.

The background colours in the Order Reference column represent the material colour.

See page 38 for Brady's range of label printers.

Diagram	Material	Special Properties	Label Width A (mm)	Label Height B (mm)	Diameter C (mm)	Printable Area Width PW (mm)	Printable Area Height PH (mm)	Order Reference	Printer Compatibility	Printer Ribbon Series	Labels/Package	Labels per Row
<b>0.5 - 0.7 ml</b>												
❖	B-499	<b>F A</b>	25.40	9.53	9.53	-	-	M71-98-499	BMP71	M71-R4300	500	1
◆	B-461	<b>F A H S L</b>	25.40	9.53	9.53	20.00	9.53	B33-606-461	BBP33	B30-R4300	1000	1
◆	B-461	<b>F A H S L</b>	25.40	9.53	9.53	20.00	9.53	BPT-606-461	BBP12, BP-PR+	R7950	1000	1
<b>0.5 - 1.5 ml</b>												
✕	B-492	<b>F H L</b>	-	-	9.53	-	-	M-82-492	BMP51, BMP53	-	240	1
✕	B-499	<b>F A</b>	-	-	9.53	-	-	M-82-499	BMP51, BMP53	-	240	1
✕	B-499	<b>F A</b>	-	-	9.53	-	-	M-82-499-OR-BK	BMP51, BMP53	-	240	1
✕	B-499	<b>F A</b>	-	-	9.53	-	-	M-82-499-RD-BK	BMP51, BMP53	-	240	1
✕	B-499	<b>F A</b>	-	-	9.53	-	-	M-82-499-YL-BK	BMP51, BMP53	-	240	1
<b>0.5 - 8.0 ml</b>												
❖	B-492	<b>F H L</b>	25.40	9.53	9.53	-	-	THT-249-492-1.5-SC	BBP12, BP-PR+	R6400	1500	1
❖	B-499	<b>F A</b>	25.40	9.53	9.53	-	-	THT-249-499-1.5-SC	BBP12, BP-PR+	R7950	1500	1
❖	B-492	<b>F H L</b>	25.40	12.70	9.53	-	-	THT-250-492-1.5-SC	BBP12, BP-PR+	R6400	1500	1
❖	B-492	<b>F H L</b>	25.40	12.70	11.18	-	-	THT-251-492-1.5-SC	BBP12, BP-PR+	R6400	1500	1
<b>0.6 - 1.5 ml</b>												
/	B-492	<b>F H L</b>	-	-	9.53	-	-	B33-143-492	BBP33	B30-R6400	1500	4
/	B-499	<b>F A</b>	-	-	9.53	-	-	B33-143-499	BBP33	B30-R6000HF	1500	4
✕	B-499	<b>F A</b>	-	-	9.53	-	-	M71-82-499	BMP71	M71-R4300	500	1
/	B-492	<b>F H L</b>	-	-	9.53	-	-	THT-143-492-3	BBP12, BP-PR+, IP	R6400	3000	4
/	B-499	<b>F A</b>	-	-	9.53	-	-	THT-143-499-3	BBP12, BP-PR+, IP	R4900	3000	4
/	B-492	<b>F H L</b>	-	-	9.53	-	-	THT-143-492-1.5-SC	BBP12, BP-PR+	R6400	1500	4
<b>0.6 - 50.0 ml</b>												
/	B-499	<b>F A</b>	-	-	9.53	-	-	B33-602-499	BBP33	B30-R6000HF	3000	3
/	B-461	<b>F A H S L</b>	-	-	9.53	-	-	B33-602-461AW**	BBP33	B30-R4300	3000	3
/	B-499	<b>F A</b>	-	-	9.53	-	-	B33-602-499YL	BBP33	B30-R6000HF	3000	3
/	B-499	<b>F A</b>	-	-	9.53	-	-	BPT-602-499	BBP12, BP-PR+	R7950	3000	3
✕	B-461	<b>F A H S L</b>	-	-	9.53	-	-	BPT-602-461AW**	BBP12, BP-PR+	R7950	3000	3
/	B-499	<b>F A</b>	-	-	9.53	-	-	BPT-602-499YL	BBP12, BP-PR+	R7950	3000	3
/	B-499	<b>F A</b>	-	-	12.70	-	-	B33-603-499	BBP33	B30-R6000HF	3000	3
/	B-499	<b>F A</b>	-	-	12.70	-	-	B33-603-499YL	BBP33	B30-R6000HF	3000	3
/	B-499	<b>F A</b>	-	-	12.70	-	-	BPT-603-499	BBP12, BP-PR+	R7950	3000	3
/	B-499	<b>F A</b>	-	-	12.70	-	-	BPT-603-499YL	BBP12, BP-PR+	R7950	3000	3
/	B-461	<b>F A H S L</b>	-	-	15.24	-	-	B33-604-461AW**	BBP33	B30-R4300	3000	3
✕	B-461	<b>F A H S L</b>	-	-	15.24	-	-	BPT-604-461AW**	BBP12, BP-PR+	R7950	3000	3

\*\*AW = All White / no transparent area.

>>

# Vial Top Labels

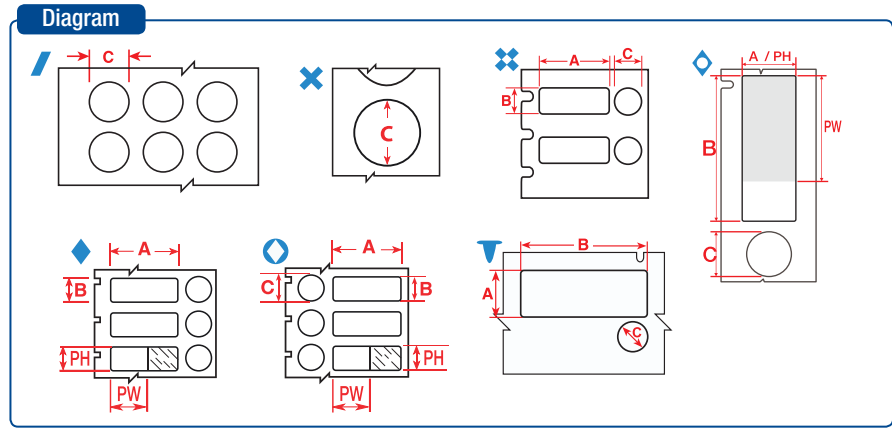

Diagram	Material	Special Properties	Label Width A (mm)	Label Height B (mm)	Diameter C (mm)	Printable Area Width PW (mm)	Printable Area Height PH (mm)	Order Reference	Printer Compatibility	Printer Ribbon Series	Labels/Package	Labels per Row
<b>1.0 - 2.0 ml</b>												
/	B-490	F H L	-	-	12.70	-	-	B33-144-490	BBP33	B30-R4300	2500	3
/	B-492	F H L	-	-	12.70	-	-	B33-144-492	BBP33	B30-R6400	1500	3
/	B-499	F A	-	-	12.70	-	-	B33-144-499	BBP33	B30-R6000HF	1500	3
X	B-499	F A	-	-	12.70	-	-	M71-83-499	BMP71	M71-R4300	500	1
/	B-492	F H L	-	-	12.70	-	-	THT-144-492-3	BBP12, BP-PR+, IP	R6400	3000	3
/	B-499	F A	-	-	12.70	-	-	THT-144-499-3	BBP12, BP-PR+, IP	R4900	3000	3
/	B-492	F H L	-	-	12.70	-	-	THT-144-492-1.5-SC	BBP12, BP-PR+	R6400	1500	3
/	B-499	F A	-	-	12.70	-	-	THT-144-499-1.5-SC	BBP12, BP-PR+	R7950	1500	3
◇	B-461	F A H S L	15.24	41.28	12.70	15.24	30.00	M71-116-461	BMP71	M71-R6200	150	1
⊗	B-492	F H L	25.40	9.53	9.53	-	-	B33-163-492	BBP33	B30-R6400	1500	1
⊗	B-499	F A	25.40	9.53	9.53	-	-	B33-163-499	BBP33	B30-R6000HF	1500	1
⊗	B-492	F H L	25.40	9.53	9.53	-	-	M-118-492	BMP51, BMP53	-	240	1
⊗	B-499	F A	25.40	9.53	9.53	-	-	M-118-499	BMP51, BMP53	-	240	1
⊗	B-492	F H L	25.40	9.53	9.53	-	-	THT-163-492-3	BBP12, BP-PR+, IP	R6400	3000	1
⊗	B-499	F A	25.40	9.53	9.53	-	-	THT-163-499-3	BBP12, BP-PR+, IP	R4900	3000	1
⊗	B-492	F H L	25.40	12.70	9.53	-	-	M71-118-492	BMP71	M71-R6400	500	1
⊗	B-492	F H L	25.40	12.70	9.53	-	-	THT-181-492-3	BBP12, BP-PR+, IP	R6400	3000	1
⊗	B-492	F H L	25.40	12.70	11.18	-	-	B33-182-492	BBP33	B30-R6400	1500	1
⊗	B-492	F H L	25.40	12.70	11.18	-	-	THT-182-492-3	BBP12, BP-PR+, IP	R6400	3000	1
◇	B-461	F A H S L	40.00	15.00	9.00	30.00	15.00	BPTLAB-20-461-2.5	BBP12, BP-PR+	R7950	2500	1
◇	B-461	F A H S L	40.00	15.00	9.53	30.00	15.00	M71-101-461	BMP71	M71-R6200	250	1
⊗	B-499	F A	41.28	15.24	12.70	-	-	BPT-608-499	BBP12, BP-PR+	R7950	1000	1
◇	B-461	F A H S L	41.28	15.24	12.70	30.00	15.24	B33-608-461	BBP33	B30-R4300	1000	1
◇	B-461	F A H S L	41.28	15.24	12.70	30.00	15.24	BPT-608-461	BBP12, BP-PR+	R7950	1000	1
<b>1.0 - 8.0 ml</b>												
⊗	B-490	F H L	22.86	12.70	12.70	-	-	B33-126-490	BBP33	B30-R4300	2500	1
⊗	B-499	F A	22.86	12.70	12.70	-	-	B33-126-499	BBP33	B30-R6000HF	1500	1
⊗	B-499	F A	22.86	12.70	12.70	-	-	M71-126-499	BMP71	M71-R4300	500	1
⊗	B-499	F A	22.86	12.70	12.70	-	-	THT-126-499-3	BBP12, BP-PR+, IP	R4900	3000	1
⊗	B-492	F H L	41.28	15.24	9.53	-	-	B33-190-492	BBP33	R6400	1500	1
⊗	B-492	F H L	41.28	15.24	9.53	-	-	THT-190-492-3	BBP12, BP-PR+, IP	R6400	3000	1
<b>1.5 - 2.0 ml</b>												
X	B-492	F H L	-	-	12.70	-	-	M-83-492	BMP51, BMP53	-	240	1
X	B-499	F A	-	-	12.70	-	-	M-83-499	BMP51, BMP53	-	240	1
X	B-499	F A	-	-	12.70	-	-	M-83-499-OR-BK	BMP51, BMP53	-	240	1
X	B-499	F A	-	-	12.70	-	-	M-83-499-RD-BK	BMP51, BMP53	-	240	1
X	B-499	F A	-	-	12.70	-	-	M-83-499-YL-BK	BMP51, BMP53	-	240	1
⊗	B-492	F H L	25.40	12.70	9.53	-	-	M-120-492	BMP51, BMP53	-	240	1
⊗	B-499	F A	25.40	12.70	9.53	-	-	M-120-499	BMP51, BMP53	-	240	1
⊗	B-492	F H L	25.40	12.70	11.18	-	-	M-117-492	BMP51, BMP53	-	240	1
⊗	B-499	F A	25.40	12.70	11.18	-	-	M-117-499	BMP51, BMP53	-	240	1
∇	B-492	F H L	41.28	15.24	9.53	-	-	M-95-492	BMP51, BMP53	-	200	1

F Freezer environment    A Autoclave environment    H Hot water bath (100°C)    S Self-laminating label    L Low-profile (extremely thin) label    R Removable

# Centrifuge / Microcentrifuge Labels

- F** Freezer environment
- N** Liquid nitrogen environment
- A** Autoclave environment
- H** Hot water bath (100°C)
- S** Self-laminating label
- L** Low-profile (extremely thin) label
- R** Removable

## CENTRIFUGE / MICROCENTRIFUGE LABELS

Brady offers a wide range of Centrifuge, Eppendorf and PCR Labels. When applying a self-laminating label, we recommend you avoid touching the adhesive side of the label when wrapping it around a vial or tube, to ensure maximum adhesion.

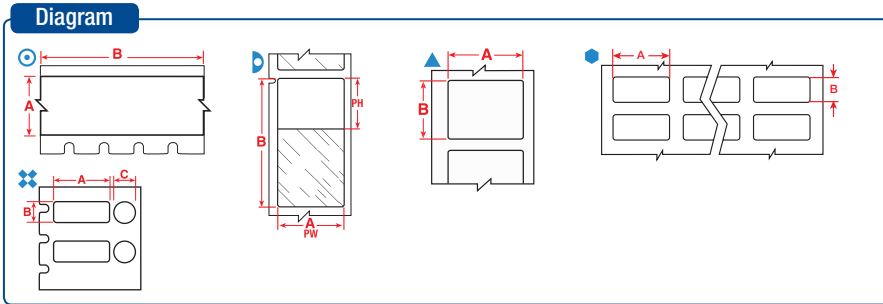
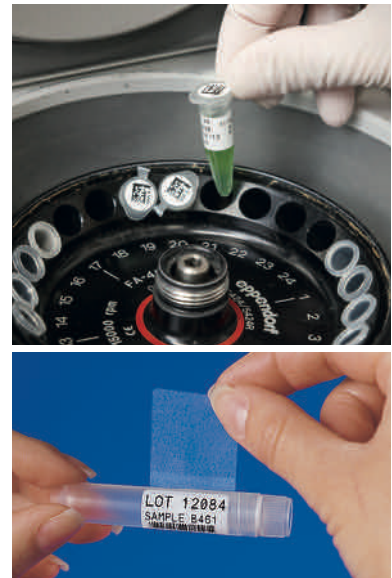

Labels are shown per vial / tube size and in order of label width.

The background colours in the Order Reference column represent the material colour.

See page 38 for Brady's range of label printers.

Diagram	Material	Special Properties	Label Width A (mm)	Label Height B (mm)	Label Length B (m)	Diameter C (mm)	Printable Area Width PW (mm)	Printable Area Height PH (mm)	Order Reference	Printer Compatibility	Printer Ribbon Series	Labels/Package	Labels per Row
<b>0.5 ml</b>													
⊙	B-423	<b>F AH</b>	6.35	-	6.40	-	-	-	M21-250-423	BMP21-LAB	-	1	1
▷	B-461	<b>F NAHSL</b>	6.35	27.94	-	-	6.35	22.00	B33-627-461*	BBP33	B30-R4300	1000	1
▷	B-461	<b>F NAHSL</b>	6.35	27.94	-	-	6.35	22.00	BPT-627-461*	BBP12	R7950	1000	1
<b>0.5 - 0.7 ml</b>													
▷	B-461	<b>F NAHSL</b>	5.08	22.86	-	-	5.08	18.00	BPT-614-461*	BBP12	R7950	2000	1
▷	B-461	<b>F NAHSL</b>	5.08	22.86	-	-	5.08	18.23	B33-614-461*	BBP33	B30-R4300	2000	1
▷	B-461	<b>F NAHSL</b>	9.53	19.05	-	-	9.53	19.05	B33-123-461*	BBP33	B30-R4300	1500	1
▷	B-461	<b>F NAHSL</b>	9.53	19.05	-	-	9.53	19.05	THT-123-461-1.5-SC*	BBP12, BP-PR+	R7950	1500	1
▲	B-498	<b>F</b>	9.53	25.40	-	-	-	-	M71-16-498	BMP71	M71-R6200	500	1
▲	B-499	<b>F NA</b>	9.53	25.40	-	-	-	-	M71-16-499	BMP71	M71-R4300	500	1
▷	B-461	<b>F NAHSL</b>	9.53	28.58	-	-	9.53	19.05	M-123-461	BMP51, BMP53	-	360	1
▷	B-461	<b>F NAHSL</b>	9.53	45.72	-	-	9.53	19.05	M71-73-461	BMP71	M71-R6200	250	1
▷	B-461	<b>F NAHSL</b>	9.53	45.72	-	-	9.53	19.05	THT-123-461-3*	BBP12, BP-PR+, IP	R4300, R7950	3000	1
⬢	B-490	<b>F N H L</b>	12.70	19.05	-	-	-	-	B33-68-490	BBP33	B30-R4300	2500	4
⬢	B-499	<b>F NA</b>	12.70	19.05	-	-	-	-	B33-68-499	BBP33	B30-R6000HF	1500	4
⬢	B-499	<b>F NA</b>	12.70	19.05	-	-	-	-	THT-68-499-10	BBP12, BP-PR+, IP	R4900	10000	4
▷	B-461	<b>F NAHSL</b>	12.70	28.58	-	-	12.70	19.05	M-122-461	BMP51, BMP53	-	360	1
▷	B-461	<b>F NAHSL</b>	12.70	44.45	-	-	12.70	19.05	M-72-461	BMP51, BMP53	-	180	1
▷	B-461	<b>F NAHSL</b>	12.70	45.72	-	-	12.70	19.05	B33-122-461*	BBP33	B30-R4300	1500	1
▷	B-461	<b>F NAHSL</b>	12.70	45.72	-	-	12.70	19.05	THT-122-461-3*	BBP12, BP-PR+, IP	R4300, R7950	3000	1
▷	B-461	<b>F NAHSL</b>	12.70	45.72	-	-	12.70	19.05	THT-122-461-1.5-SC*	BBP12, BP-PR+	R7950	1500	1
▷	B-461	<b>F NAHSL</b>	12.70	55.88	-	-	12.70	19.05	B33-127-461	BBP33	B30-R4300	1500	3
▷	B-427	<b>F N S</b>	12.70	55.88	-	-	12.70	19.05	THT-127-427-3*	BBP12, BP-PR+, IP	R4300, R7950	3000	1
▷	B-461	<b>F NAHSL</b>	12.70	55.88	-	-	12.70	19.05	THT-127-461-3*	BBP12, BP-PR+, IP	R4300, R7950	3000	1
▷	B-461	<b>F NAHSL</b>	12.70	55.88	-	-	12.70	19.05	THT-127-461-1.5-SC*	BBP12, BP-PR+	R7950	1500	1
▲	B-498	<b>F</b>	19.05	12.70	-	-	-	-	BM71-11-498	BMP71	M71-R6200	5000	1
▲	B-499	<b>F NA</b>	19.05	12.70	-	-	-	-	BM71-11-499	BMP71	M71-R4300	5000	1
▲	B-499	<b>F NA</b>	19.05	12.70	-	-	-	-	M-11-499	BMP51, BMP53	-	220	1
▲	B-498	<b>F</b>	19.05	12.70	-	-	-	-	M71-11-498	BMP71	M71-R6200	500	1
▲	B-499	<b>F NA</b>	19.05	12.70	-	-	-	-	M71-11-499	BMP71	M71-R4300	500	1
⬢	B-492	<b>F N H L</b>	25.40	9.53	-	-	-	-	B33-152-492	BBP33	B30-R6400	2500	2
⬢	B-499	<b>F NA</b>	25.40	9.53	-	-	-	-	B33-152-499	BBP33	B30-R6000HF	1500	2
▲	B-492	<b>F N H L</b>	25.40	9.53	-	-	-	-	M71-16-492	BMP71	M71-R6400	500	1
⊗	B-499	<b>F A</b>	25.40	9.53	-	9.53	-	-	M71-98-499	BMP71	M71-R4300	500	1
⬢	B-492	<b>F N H L</b>	25.40	9.53	-	-	-	-	THT-152-492-3	BBP12, BP-PR+, IP	R6400	3000	2

\*Label is rotated 90° on liner.

>>

**i** These labels are also suitable for Eppendorf tubes and PCR process.

# Centrifuge / Microcentrifuge Labels

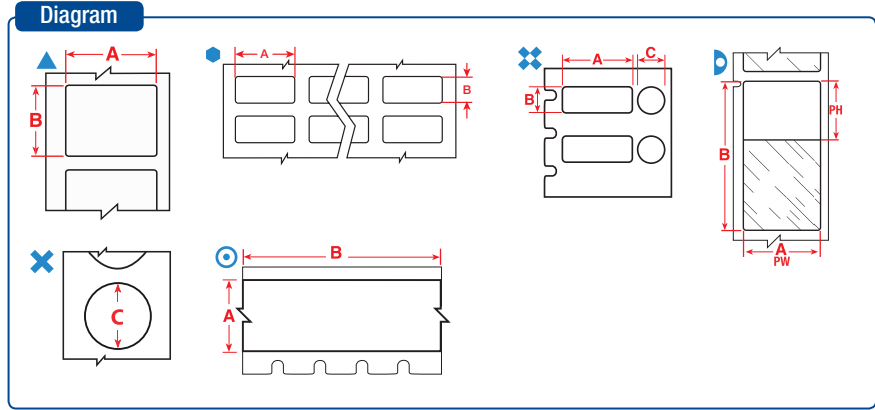

Labels are shown per vial / tube size and in order of label width.

The background colours in the Order Reference column represent the material colour.

See page 38 for Brady's range of label printers.

Diagram	Material	Special Properties	Label Width A (mm)	Label Height B (mm)	Label Length B (m)	Diameter C (mm)	Printable Area Width PW (mm)	Printable Area Height PH (mm)	Order Reference	Printer Compatibility	Printer Ribbon Series	Labels/Package	Labels per Row
<b>0.5 - 0.7 ml</b>													
●	B-499	<b>F N A</b>	25.40	9.53	-	-	-	-	THT-152-499-3	BBP12, BP-PR+, IP	R4900	3000	2
▲	B-492	<b>F N H L</b>	25.40	9.53	-	-	-	-	THT-152-492-2.5-SC	BBP12, BP-PR+	R6400	2500	2
●	B-499	<b>F N A</b>	25.40	9.53	-	-	-	-	THT-152-499-1.5-SC	BBP12, BP-PR+	R7950	1500	2
●	B-425	<b>F</b>	25.40	9.98	-	-	-	-	THT-30-425-10	BBP12, BP-PR+, IP	R6400	10000	3
▲	B-490	<b>F N H L</b>	31.75	9.53	-	-	-	-	B33-154-490	BBP33	B30-R4300	1500	1
▲	B-490	<b>F N H L</b>	31.75	9.53	-	-	-	-	M-112-490	BMP51, BMP53	-	360	1
▲	B-492	<b>F N H L</b>	31.75	9.53	-	-	-	-	M-112-492	BMP51, BMP53	-	360	1
▲	B-490	<b>F N H L</b>	31.75	9.53	-	-	-	-	THT-154-490-3	BBP12, BP-PR+, IP	R4306	3000	1
▲	B-490	<b>F N H L</b>	31.75	9.53	-	-	-	-	THT-154-490-1.5-SC	BBP12, BP-PR+	R7950	1500	1
<b>0.5 - 1.5 ml</b>													
✕	B-492	<b>F H L</b>	-	-	-	9.53	-	-	M-82-492	BMP51, BMP53	-	240	1
✕	B-499	<b>F A</b>	-	-	-	9.53	-	-	M-82-499-RD-BK	BMP51, BMP53	-	240	1
<b>0.6 ml</b>													
○	B-499	<b>F N A</b>	9.53	-	4.88	-	-	-	M21-375-499	BMP21-LAB	-	1	1
○	B-499	<b>F N A</b>	9.53	-	4.88	-	-	-	MC-375-499	BMP51, BMP53	-	1	1
○	B-461	<b>F N A H S L</b>	9.53	-	6.40	-	9.53	-	M21-375-461-AW**	BMP21-LAB	-	1	1
▲	B-492	<b>F N H L</b>	9.53	20.96	-	-	-	-	M-130-492	BMP51, BMP53	-	220	1
▲	B-499	<b>F N A</b>	9.53	20.96	-	-	-	-	M-130-499	BMP51, BMP53	-	220	1
▲	B-499	<b>F N A</b>	22.86	12.70	-	-	-	-	M71-84-499	BMP71	M71-R4300	500	1
▲	B-499	<b>F N A</b>	22.86	12.70	-	-	-	-	M-84-499	BMP51, BMP53	-	200	1
▲	B-492	<b>F N H L</b>	31.75	6.35	-	-	-	-	M-155-492	BMP51, BMP53	-	180	1
<b>1.0 - 2.0 ml</b>													
✘	B-492	<b>F H L</b>	25.40	9.53	-	9.53	-	-	M-118-492	BMP51, BMP53	-	240	1
✘	B-499	<b>F A</b>	25.40	9.53	-	9.53	-	-	M-118-499	BMP51, BMP53	-	240	1
<b>1.0 - 8.0 ml</b>													
▲	B-490	<b>F N H L</b>	41.28	15.24	-	-	-	-	THT-155-490-3	BBP12, BP-PR+, IP	R4300, R7950	3000	1
▲	B-492	<b>F N H L</b>	12.70	25.40	-	-	-	-	M-131-492	BMP51, BMP53	-	180	1
▲	B-499	<b>F N A</b>	12.70	25.40	-	-	-	-	M-131-499	BMP51, BMP53	-	180	1
▷	B-461	<b>F N A H S L</b>	12.70	55.88	-	-	12.70	19.05	M-74-461	BMP51, BMP53	-	140	1
▷	B-461	<b>F N A H S L</b>	15.24	41.28	-	-	15.24	25.40	M71-76-461	BMP71	M71-R6200	500	1
▲	B-490	<b>F N H L</b>	15.24	45.72	-	-	-	-	M-126-490	BMP51, BMP53	-	180	1
▷	B-461	<b>F N A H S L</b>	15.24	45.72	-	-	15.24	25.40	M-126-461	BMP51, BMP53	-	180	1
▷	B-461	<b>F N A H S L</b>	15.24	66.68	-	-	15.24	25.40	B33-153-461*	BBP33	B30-R4300	1500	1
▷	B-461	<b>F N A H S L</b>	15.24	66.68	-	-	15.24	25.40	M71-86-461	BMP71	M71-R6200	100	1
▷	B-461	<b>F N A H S L</b>	15.24	66.68	-	-	15.24	25.40	M-86-461	BMP51, BMP53	-	120	1
✘	B-499	<b>F A</b>	22.86	12.70	-	12.70	-	-	M71-126-499	BMP71	M71-R4300	500	1
✘	B-499	<b>F A</b>	22.86	12.70	-	12.70	-	-	THT-126-499-3	BBP12, BP-PR+, IP	R4900	3000	1
▲	B-490	<b>F N H L</b>	41.28	15.24	-	-	-	-	B33-155-490	BBP33	B30-R4300	1500	1

\*Label is rotated 90° on liner. \*\*AW = All White / no transparent area.

>>>

**i** These labels are also suitable for Eppendorf tubes and PCR process.

**F** Freezer environment **N** Liquid nitrogen environment **A** Autoclave environment **H** Hot water bath (100°C) **S** Self-laminating label **L** Low-profile (extremely thin) label **R** Removable



# Centrifuge / Microcentrifuge Labels

Diagram

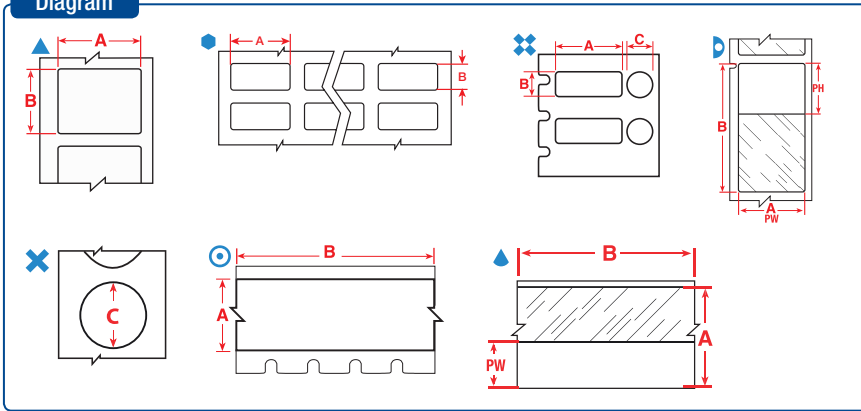
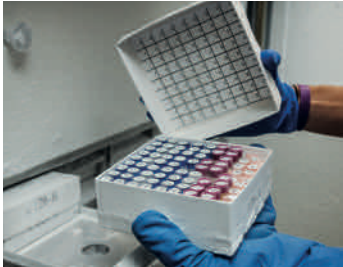

Diagram	Material	Special Properties	Label Width A (mm)	Label Height B (mm)	Label Length B (mm)	Diameter C (mm)	Printable Area Width PW (mm)	Printable Area Height PH (mm)	Order Reference	Printer Compatibility	Printer Ribbon Series	Labels/Package	Labels per Row
<b>1.0 - 8.0 ml</b>													
▲	B-492	<b>F N H L</b>	41.28	15.24	-	-	-	-	B33-155-492	BBP33	R6400	1500	1
▲	B-490	<b>F N H L</b>	41.28	15.24	-	-	-	-	M71-76-490	BMP71	M71-R4300	500	1
▲	B-490	<b>F N H L</b>	41.28	15.24	-	-	-	-	THT-155-490-1.5-SC	BBP12, BP-PR+	R7950	1500	1
▲	B-492	<b>F N H L</b>	41.28	15.24	-	-	-	-	THT-155-492-3	BBP12, BP-PR+, IP	R6400	3000	1
<b>1.5 ml</b>													
⊙	B-499	<b>F N A</b>	12.70	-	4.88	-	-	-	M21-500-499	BMP21-LAB	-	1	1
⊙	B-499	<b>F N A</b>	12.70	-	4.88	-	-	-	MC-500-499	BMP51, BMP53	-	1	1
⊙	B-461	<b>F N A H S L</b>	12.70	-	6.40	-	12.70	-	M21-500-461-AW**	BMP21-LAB	-	1	1
⊙	B-492	<b>F N H L</b>	12.70	-	7.62	-	-	-	MC-500-492	BMP51, BMP53	-	1	1
⊙	B-461	<b>F N A H S L</b>	12.70	-	7.62	-	12.70	-	MC-500-461-AW**	BMP51, BMP53	-	1	1
⊙	B-499	<b>F N A</b>	12.70	-	9.10	-	-	-	M71C-500-499	BMP71	M71-R4300	1	1
<b>1.5 - 2.0 ml</b>													
×	B-492	<b>F H L</b>	-	-	-	12.70	-	-	M-83-492	BMP51, BMP53	-	240	1
×	B-499	<b>F A</b>	-	-	-	12.70	-	-	M-83-499-OR-BK	BMP51, BMP53	-	240	1
×	B-499	<b>F A</b>	-	-	-	12.70	-	-	M-83-499-RD-BK	BMP51, BMP53	-	240	1
▲	B-490	<b>F N H L</b>	12.70	41.91	-	-	-	-	M-124-490	BMP51, BMP53	-	180	1
▷	B-461	<b>F N A H S L</b>	12.70	41.91	-	-	12.70	19.05	M-124-461	BMP51, BMP53	-	180	1
▷	B-461	<b>F N A H S L</b>	15.24	41.28	-	-	15.24	25.40	THT-133-461-1.5-SC*	BBP12, BP-PR+	R7950	1500	1
▷	B-461	<b>F N A H S L</b>	15.24	41.28	-	-	15.24	25.40	THT-133-461-3*	BBP12, BP-PR+, IP	R4300, R7950	3000	1
▷	B-461	<b>F N A H S L</b>	15.24	66.68	-	-	15.24	25.40	THT-153-461-1.5-SC*	BBP12, BP-PR+	R7950	1500	1
▷	B-461	<b>F N A H S L</b>	15.24	66.68	-	-	15.24	25.40	THT-153-461-3*	BBP12, BP-PR+, IP	R4300, R7950	3000	1
▲	B-492	<b>F N H L</b>	25.40	12.70	-	-	-	-	B33-59-492	BBP33	B30-R6400	2500	1
▲	B-492	<b>F N H L</b>	25.40	12.70	-	-	-	-	THT-59-492-10	BBP12, BP-PR+, IP	R6400	10000	1
▲	B-492	<b>F N H L</b>	25.40	12.70	-	-	-	-	THT-59-492-2.5-SC	BBP12, BP-PR+	R6400	2500	1
×	B-492	<b>F H L</b>	25.40	12.70	-	9.53	-	-	M-120-492	BMP51, BMP53	-	240	1
×	B-499	<b>F A</b>	25.40	12.70	-	9.53	-	-	M-120-499	BMP51, BMP53	-	240	1
×	B-492	<b>F H L</b>	25.40	12.70	-	11.18	-	-	M-117-492	BMP51, BMP53	-	240	1
×	B-499	<b>F A</b>	25.40	12.70	-	11.18	-	-	M-117-499	BMP51, BMP53	-	240	1
▲	B-492	<b>F N H L</b>	41.91	12.70	-	-	-	-	M-124-492	BMP51, BMP53	-	180	1
<b>2.0 - 50.0 ml</b>													
▲	B-427	<b>F N S</b>	19.05	-	4.30	-	9.53	-	M21-750-427	BMP21-PLUS; BMP21	-	1	-
⊙	B-499	<b>F N A</b>	19.05	-	4.88	-	-	-	M21-750-499	BMP21-LAB	-	1	1
⊙	B-499	<b>F N A</b>	19.05	-	4.88	-	-	-	MC-750-499	BMP51, BMP53	-	1	1
⊙	B-461	<b>F N A H S L</b>	19.05	-	6.40	-	19.05	-	M21-750-461-AW**	BMP21-LAB	-	1	1
▲	B-427	<b>F N S</b>	19.05	-	7.62	-	9.53	-	MC-750-427	BMP51, BMP53	-	1	1
⊙	B-499	<b>F N A</b>	25.40	-	4.88	-	-	-	MC-1000-499	BMP51, BMP53	-	1	1
⊙	B-499	<b>F N A</b>	25.40	-	9.10	-	-	-	M71C-1000-499	BMP71	M71-R4300	1	1
<b>5.0 - 50.0 ml</b>													
⊙	B-499	<b>F N A</b>	48.26	-	9.10	-	-	-	M71C-1900-499	BMP71	M71-R4300	1	1

\*Label is rotated 90° on liner. \*\*AW = All White / no transparent area.

**i** These labels are also suitable for Eppendorf tubes and PCR process.

**F** Freezer environment **N** Liquid nitrogen environment **A** Autoclave environment **H** Hot water bath (100°C) **S** Self-laminating label **L** Low-profile (extremely thin) label **R** Removable



## CRYO TUBES & VIALS

Brady's offers a range of labels designed specifically to identify laboratory samples for cryo storage. These labels can be applied to room temperature or to already frozen samples, albeit with a small overlap. The label will remain legible and will stick to the sample container during processing, even when exposed to extreme heat or chemicals like DMSO, Xylene and Ethanol, ensuring secure sample identification in the most challenging laboratory conditions.

- F** Freezer environment
- N** Liquid nitrogen environment
- A** Autoclave environment
- H** Hot water bath (100°C)
- S** Self-laminating label
- L** Low-profile (extremely thin) label
- R** Removable

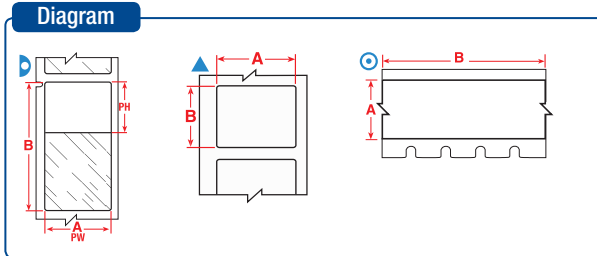

The background colours in the Order Reference column represent the material colour

See page 38 for Brady's range of label printers.

Labels are shown per vial / tube size and in order of label width.

Diagram	Material	Special Properties	Label Width A (mm)	Label Height B (mm)	Label Length B (m)	Printable Area Width PW (mm)	Printable Area Height PH (mm)	Order Reference	Printer Compatibility	Printer Ribbon Series	Labels/Package	Labels per Row
<b>0.5 - 0.7 ml</b>												
▷	B-461	<b>F N A H S L</b>	9.53	28.58	–	9.53	19.05	M-123-461	BMP51, BMP53	–	360	1
▷	B-461	<b>F N A H S L</b>	12.70	28.58	–	12.70	19.05	M-122-461	BMP51, BMP53	–	360	1
▷	B-461	<b>F N A H S L</b>	12.70	44.45	–	12.70	19.05	M-72-461	BMP51, BMP53	–	180	1
▲	B-499	<b>F N A</b>	19.05	12.70	–	–	–	BM71-11-499	BMP71	M71-R4300	5000	1
▲	B-499	<b>F N A</b>	19.05	12.70	–	–	–	M-11-499	BMP51, BMP53	–	220	1
▲	B-499	<b>F N A</b>	19.05	12.70	–	–	–	M71-11-499	BMP71	M71-R4300	500	1
▲	B-490	<b>F N H L</b>	31.75	9.53	–	–	–	M-112-490	BMP51, BMP53	–	360	1
<b>0.6 ml</b>												
⊙	B-499	<b>F N A</b>	9.53	–	4.88	–	–	M21-375-499	BMP21-LAB	–	1	1
⊙	B-499	<b>F N A</b>	9.53	–	4.88	–	–	MC-375-499	BMP51, BMP53	–	1	1
⊙	B-461	<b>F N A H S L</b>	9.53	–	6.40	9.53	–	M21-375-461-AW**	BMP21-LAB	–	1	1
⊙	B-461	<b>F N A H S L</b>	9.53	–	7.62	9.53	–	MC-375-461-AW**	BMP51, BMP53	–	1	1
▲	B-492	<b>F N H L</b>	9.53	20.96	–	–	–	M-130-492	BMP51, BMP53	–	220	1
▲	B-499	<b>F N A</b>	9.53	20.96	–	–	–	M-130-499	BMP51, BMP53	–	220	1
▲	B-499	<b>F N A</b>	22.86	12.70	–	–	–	M-84-499	BMP51, BMP53	–	200	1
<b>1.0 - 8.0 ml</b>												
▲	B-492	<b>F N H L</b>	12.70	25.40	–	–	–	M-131-492	BMP51, BMP53	–	180	1
▲	B-499	<b>F N A</b>	12.70	25.40	–	–	–	M-131-499	BMP51, BMP53	–	180	1
▷	B-461	<b>F N A H S L</b>	12.70	55.88	–	12.70	19.05	M-74-461	BMP51, BMP53	–	140	1
▲	B-490	<b>F N H L</b>	15.24	45.72	–	–	–	M-126-490	BMP51, BMP53	–	180	1
▷	B-461	<b>F N A H S L</b>	15.24	45.72	–	15.24	25.40	M-126-461	BMP51, BMP53	–	180	1
▷	B-461	<b>F N A H S L</b>	15.24	66.68	–	15.24	25.40	M-86-461	BMP51, BMP53	–	120	1
▲	B-490	<b>F N H L</b>	25.40	44.45	–	–	–	M-125-490	BMP51, BMP53	–	180	1
▷	B-461	<b>F N A H S L</b>	25.40	44.45	–	25.40	25.40	M-125-461	BMP51, BMP53	–	180	1
▷	B-461	<b>F N A H S L</b>	25.40	66.68	–	25.40	25.40	BM71-75-461	BMP71	M71-R6200	1000	1
▷	B-461	<b>F N A H S L</b>	25.40	66.68	–	25.40	25.40	M-75-461	BMP51, BMP53	–	120	1

\*\*AW = All White / no transparent area.

>>

### Part number explanation

Most Brady references for printable labels follow the same three-part format: The first code indicates the technology, the second part is a number indicating the label size (where applicable) and the third part indicates the Brady material (where applicable).

## M71-73-461

BMP71  
Technology

Label size  
code

Material  
(B-number)

## Diagram

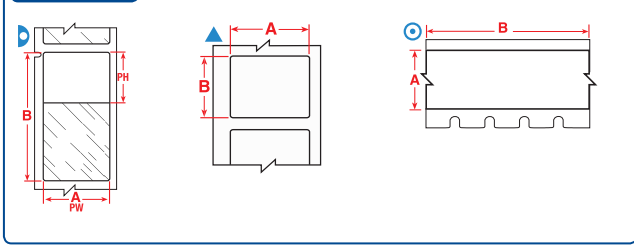

Labels are shown per vial / tube size and in order of label width.

The background colours in the Order Reference column represent the material colour.

See page 38 for Brady's range of label printers.

Diagram	Material	Special Properties	Label Width A (mm)	Label Height B (mm)	Label Length B (m)	Printable Area Width PW (mm)	Printable Area Height PH (mm)	Order Reference	Printer Compatibility	Printer Ribbon Series	Labels/Package	Labels per Row
<b>1.0 - 15 ml</b>												
▲	B-492	<b>F N H L</b>	22.86	25.40	-	-	-	M-156-492	BMP51, BMP53	-	180	1
<b>1.5 ml</b>												
⊙	B-499	<b>F N A</b>	12.70	-	4.88	-	-	M21-500-499	BMP21-LAB	-	1	1
⊙	B-499	<b>F N A</b>	12.70	-	4.88	-	-	MC-500-499	BMP51, BMP53	-	1	1
⊙	B-461	<b>F N A H S L</b>	12.70	-	6.40	12.70	-	M21-500-461-AW**	BMP21-LAB	-	1	1
⊙	B-461	<b>F N A H S L</b>	12.70	-	7.62	12.70	-	MC-500-461-AW**	BMP51, BMP53	-	1	1
⊙	B-499	<b>F N A</b>	12.70	-	9.10	-	-	M71C-500-499	BMP71	M71-R4300	1	1
<b>2.0 - 50.0 ml</b>												
⊙	B-499	<b>F N A</b>	19.05	-	4.88	-	-	M21-750-499	BMP21-LAB	-	1	1
⊙	B-499	<b>F N A</b>	19.05	-	4.88	-	-	MC-750-499	BMP51, BMP53	-	1	1
⊙	B-461	<b>F N A H S L</b>	19.05	-	6.40	19.05	-	M21-750-461-AW**	BMP21-LAB	-	1	1
⊙	B-499	<b>F N A</b>	25.40	-	4.88	-	-	MC-1000-499	BMP51, BMP53	-	1	1
⊙	B-461	<b>F N A H S L</b>	25.40	-	7.62	25.40	-	MC-1000-461-AW**	BMP51, BMP53	-	1	1
⊙	B-499	<b>F N A</b>	25.40	-	9.10	-	-	M71C-1000-499	BMP71	M71-R4300	1	1
<b>4.0 - 50.0 ml</b>												
⊙	B-461	<b>F N A H S L</b>	31.75	-	7.62	31.75	-	MC-1250-461-AW**	BMP51, BMP53	-	1	1
<b>12.0 - 14.0 ml</b>												
▶	B-461	<b>F N A H S L</b>	38.10	95.25	-	38.10	31.75	M-119-461	BMP51, BMP53	-	80	1
<b>12.0 - 24.0 ml</b>												
▲	B-492	<b>F N H L</b>	25.40	48.26	-	-	-	M-78-492	BMP51, BMP53	-	100	1
▲	B-499	<b>F N A</b>	38.10	12.70	-	-	-	M71-29-499	BMP71	M71-R4300	500	1
▲	B-499	<b>F N A</b>	38.10	31.75	-	-	-	M-132-499	BMP51, BMP53	-	160	1

\*\*AW = All White / no transparent area.



## B-492 (FreezerBondz™)

“The special FreezerBondz™ labels are very reliable: they stick to the glass vials we use for our frozen fish tissue samples and, just as important, they remain readable to maintain accurate sample identification in long-term storage.”

*Centre for Ecology & Hydrology, UK*



# Conical / Large Tube Labels



## CONICAL / LARGE TUBE LABELS

Brady offers several sample identification labels which are perfect to identify conicals. They are easy to handle, have great flexibility and easily wrap around curved sample containers. Your sample identification label will remain attached and legible, even when the sample is stored in a freezer, in liquid nitrogen or heated in an autoclave.

- F** Freezer environment
- N** Liquid nitrogen environment
- A** Autoclave environment
- H** Hot water bath (100°C)
- S** Self-laminating label
- L** Low-profile (extremely thin) label
- R** Removable

Diagram

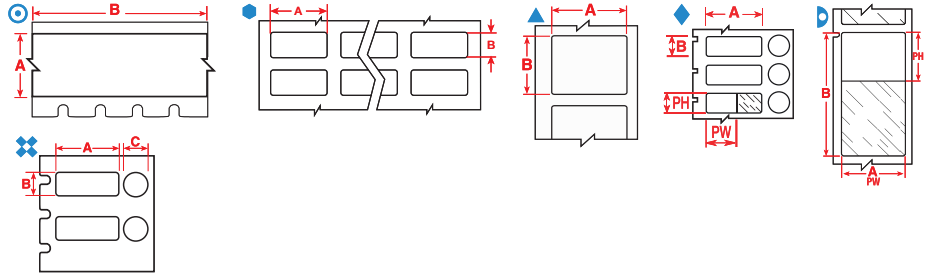

Labels are shown per vial / tube size and in order of label width.

The background colours in the Order Reference column represent the material colour.

See page 38 for Brady's range of label printers.

Diagram	Material	Special Properties	Label Width A (mm)	Label Height B (mm)	Label Length B (m)	Diameter C (mm)	Printable Area Width PW (mm)	Printable Area Height PH (mm)	Order Reference	Printer Compatibility	Printer Ribbon Series	Labels/Package	Labels per Row
<b>0.5 ml</b>													
○	B-423	<b>F A H</b>	6.35	-	6.40	-	-	-	M21-250-423	BMP21-LAB	-	1	1
<b>0.5 - 0.7 ml</b>													
⬢	B-499	<b>F N A</b>	12.70	19.05	-	-	-	-	B33-68-499	BBP33	B30-R6000HF	1500	4
⬢	B-499	<b>F N A</b>	12.70	19.05	-	-	-	-	THT-68-499-10	BBP12, BP-PR+, IP	R4900	10000	4
▲	B-499	<b>F N A</b>	12.70	25.40	-	-	-	-	B33-620-499	BBP33	B30-R6000HF	1000	1
▲	B-499	<b>F N A</b>	12.70	25.40	-	-	-	-	BPT-620-499	BBP12, BP-PR+	R7950	1000	1
▷	B-461	<b>F N A H S L</b>	12.70	55.88	-	-	12.70	19.05	B33-127-461	BBP33	B30-R4300	1500	3
▷	B-427	<b>F N S</b>	12.70	55.88	-	-	12.70	19.05	THT-127-427-3*	BBP12, BP-PR+, IP	R4300, R7950	3000	1
▷	B-461	<b>F N A H S L</b>	12.70	55.88	-	-	12.70	19.05	THT-127-461-1.5-SC*	BBP12, BP-PR+	R7950	1500	1
▷	B-461	<b>F N A H S L</b>	12.70	55.88	-	-	12.70	19.05	THT-127-461-3*	BBP12, BP-PR+, IP	R4300, R7950	3000	1
▲	B-499	<b>F N A</b>	19.05	12.70	-	-	-	-	M71-11-499	BMP71	M71-R4300	500	1
⬢	B-492	<b>F N H L</b>	25.40	9.53	-	-	-	-	B33-152-492	BBP33	B30-R6400	2500	2
⬢	B-499	<b>F N A</b>	25.40	9.53	-	-	-	-	B33-152-499	BBP33	B30-R6000HF	1500	2
▲	B-492	<b>F N H L</b>	25.40	9.53	-	-	-	-	M71-16-492	BMP71	M71-R6400	500	1
▲	B-492	<b>F N H L</b>	25.40	9.53	-	-	-	-	THT-152-492-2.5-SC	BBP12, BP-PR+	R6400	2500	2
⬢	B-492	<b>F N H L</b>	25.40	9.53	-	-	-	-	THT-152-492-3	BBP12, BP-PR+, IP	R6400	3000	2
⬢	B-499	<b>F N A</b>	25.40	9.53	-	-	-	-	THT-152-499-1.5-SC	BBP12, BP-PR+	R7950	1500	2
⬢	B-499	<b>F N A</b>	25.40	9.53	-	-	-	-	THT-152-499-3	BBP12, BP-PR+, IP	R4900	3000	2
⊗	B-499	<b>F A</b>	25.40	9.53	-	9.53	-	-	M71-98-499	BMP71	M71-R4300	500	1
◆	B-461	<b>F A H S L</b>	25.40	9.53	-	9.53	20.00	9.53	B33-606-461	BBP33	B30-R4300	1000	1
◆	B-461	<b>F A H S L</b>	25.40	9.53	-	9.53	20.00	9.53	BPT-606-461	BBP12, BP-PR+	R7950	1000	1
⬢	B-425	<b>F</b>	25.40	9.98	-	-	-	-	THT-30-425-10	BBP12, BP-PR+, IP	R6400	10000	3
<b>0.5 - 8.0 ml</b>													
⊗	B-492	<b>F H L</b>	25.40	9.53	-	9.53	-	-	THT-249-492-1.5-SC	BBP12, BP-PR+	R6400	1500	1
⊗	B-499	<b>F A</b>	25.40	9.53	-	9.53	-	-	THT-249-499-1.5-SC	BBP12, BP-PR+	R7950	1500	1
⊗	B-492	<b>F H L</b>	25.40	12.70	-	9.53	-	-	THT-250-492-1.5-SC	BBP12, BP-PR+	R6400	1500	1
⊗	B-492	<b>F H L</b>	25.40	12.70	-	11.18	-	-	THT-251-492-1.5-SC	BBP12, BP-PR+	R6400	1500	1
<b>0.6 ml</b>													
○	B-499	<b>F N A</b>	9.53	-	4.88	-	-	-	M21-375-499	BMP21-LAB	-	1	1
○	B-499	<b>F N A</b>	9.53	-	4.88	-	-	-	MC-375-499	BMP51, BMP53	-	1	1
○	B-461	<b>F N A H S L</b>	9.53	-	6.40	-	9.53	-	M21-375-461-AW**	BMP21-LAB	-	1	1
▲	B-499	<b>F N A</b>	22.86	12.70	-	-	-	-	B33-125-499	BBP33	B30-R6000HF	1500	1
▲	B-499	<b>F N A</b>	22.86	12.70	-	-	-	-	M71-84-499	BMP71	M71-R4300	500	1
▲	B-499	<b>F N A</b>	22.86	12.70	-	-	-	-	THT-125-499-1.5-SC	BBP12, BP-PR+	R7950	1500	1
▲	B-499	<b>F N A</b>	22.86	12.70	-	-	-	-	THT-125-499-3	BBP12, BP-PR+, IP	R4900	3000	1

\*Label is rotated 90° on liner. \*\*AW = All White / no transparent area.

>>>



# Conical / Large Tube Labels

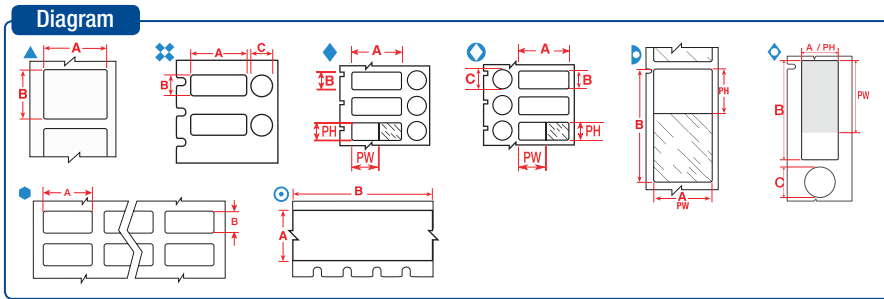
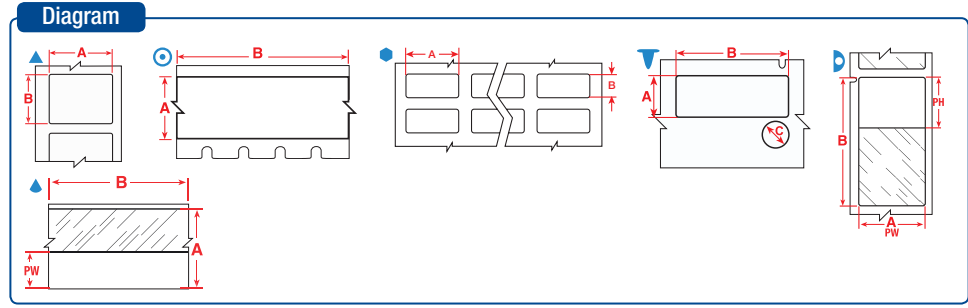

Diagram	Material	Special Properties	Label Width A (mm)	Label Height B (mm)	Label Length B (m)	Diameter C (mm)	Printable Area Width PW (mm)	Printable Area Height PH (mm)	Order Reference	Printer Compatibility	Printer Ribbon Series	Labels/Package	Labels per Row
<b>1.0 - 2.0 ml</b>													
▷	B-461	<b>FNAHSLS</b>	15.00	40.00	-	-	15.00	30.00	BPTLAB-21-461-2.5	BBP12, BP-PR+	R7950	2500	1
▷	B-461	<b>FNAHSLS</b>	15.24	38.10	-	-	15.24	33.00	BPT-628-461*	BBP12, BP-PR+	R7950	2500	2
▷	B-461	<b>FNAHSLS</b>	15.24	38.10	-	-	15.24	33.00	M71-100-461	BMP71	M71-R6200	500	1
▷	B-461	<b>FNAHSLS</b>	15.24	38.10	-	-	15.24	33.03	B33-628-461*	BBP33	B30-R4300	2500	2
◇	B-461	<b>F AHSLS</b>	15.24	41.28	-	12.70	15.24	30.00	M71-116-461	BMP71	M71-R6200	150	1
▷	B-461	<b>FNAHSLS</b>	15.24	66.68	-	-	15.24	25.40	B33-612-461	BBP33	B30-R4300	1500	3
▷	B-461	<b>FNAHSLS</b>	15.24	66.68	-	-	15.24	25.40	BPT-612-461	BBP12, BP-PR+	R7950	1500	3
⊗	B-492	<b>F H L</b>	25.40	9.53	-	9.53	-	-	THT-163-492-3	BBP12, BP-PR+, IP	R6400	3000	1
⊗	B-499	<b>F A</b>	25.40	9.53	-	9.53	-	-	THT-163-499-3	BBP12, BP-PR+, IP	R4900	3000	1
⊗	B-492	<b>F H L</b>	25.40	12.70	-	9.53	-	-	M71-118-492	BMP71	M71-R6400	500	1
⊗	B-492	<b>F H L</b>	25.40	12.70	-	9.53	-	-	THT-181-492-3	BBP12, BP-PR+, IP	R6400	3000	1
⊗	B-492	<b>F H L</b>	25.40	12.70	-	11.18	-	-	THT-182-492-3	BBP12, BP-PR+, IP	R6400	3000	1
◇	B-461	<b>F AHSLS</b>	40.00	15.00	-	9.00	30.00	15.00	BPTLAB-20-461-2.5	BBP12, BP-PR+	R7950	2500	1
◇	B-461	<b>F AHSLS</b>	40.00	15.00	-	9.53	30.00	15.00	M71-101-461	BMP71	M71-R6200	250	1
⊗	B-499	<b>F A</b>	41.28	15.24	-	12.70	-	-	BPT-608-499	BBP12, BP-PR+	R7950	1000	1
◇	B-461	<b>F AHSLS</b>	41.28	15.24	-	12.70	30.00	15.24	B33-608-461	BBP33	B30-R4300	1000	1
◇	B-461	<b>F AHSLS</b>	41.28	15.24	-	12.70	30.00	15.24	BPT-608-461	BBP12, BP-PR+	R7950	1000	1
<b>1.0 - 8.0 ml</b>													
▷	B-461	<b>FNAHSLS</b>	15.24	41.28	-	-	15.24	25.40	M71-76-461	BMP71	M71-R6200	500	1
▷	B-461	<b>FNAHSLS</b>	15.24	66.68	-	-	15.24	25.40	M71-86-461	BMP71	M71-R6200	100	1
▷	B-427	<b>FN S</b>	19.05	44.45	-	-	19.05	12.70	B33-73-427	BBP33	B30-R4300	3500	4
▷	B-427	<b>FN S</b>	19.05	44.45	-	-	19.05	12.70	THT-62-427-3.5*	BBP12, BP-PR+, IP	R4300, R7950	3500	1
▷	B-427	<b>FN S</b>	19.05	44.45	-	-	19.05	12.70	THT-73-427-10	BBP12, BP-PR+, IP	R4300, R7950	10000	4
▲	B-427	<b>FN S</b>	20.00	20.00	-	-	20.00	20.00	BPTLAB-35-427-YL	BBP12, BP-PR+	R7950	1000	1
⊗	B-499	<b>F A</b>	22.86	12.70	-	12.70	-	-	B33-126-499	BBP33	B30-R6000HF	1500	1
⊗	B-499	<b>F A</b>	22.86	12.70	-	12.70	-	-	M71-126-499	BMP71	M71-R4300	500	1
⊗	B-499	<b>F A</b>	22.86	12.70	-	12.70	-	-	THT-126-499-3	BBP12, BP-PR+, IP	R4900	3000	1
▲	B-492	<b>FN H L</b>	25.40	19.05	-	-	-	-	THT-88-492-2.5-SC	BBP12, BP-PR+	R6400	2500	2
▲	B-492	<b>FN H L</b>	25.40	19.05	-	-	-	-	THT-88-492-5	BBP12, BP-PR+, IP	R6400	5000	2
▷	B-461	<b>FNAHSLS</b>	25.40	66.68	-	-	25.40	25.40	BM71-75-461	BMP71	M71-R6200	1000	1
▷	B-461	<b>FNAHSLS</b>	25.40	66.68	-	-	25.40	25.40	M71-115-461	BMP71	M71-R6200	100	1
▷	B-461	<b>FNAHSLS</b>	25.40	66.68	-	-	25.40	25.40	THT-131-461-1.5-SC*	BBP12, BP-PR+	R7950	1500	1
▷	B-461	<b>FNAHSLS</b>	25.40	66.68	-	-	25.40	25.40	THT-131-461-3*	BBP12, BP-PR+, IP	R4300, R7950	3000	1
▲	B-490	<b>FN H L</b>	41.28	15.24	-	-	-	-	B33-155-490	BBP33	B30-R4300	1500	1
▲	B-492	<b>FN H L</b>	41.28	15.24	-	-	-	-	B33-155-492	BBP33	R6400	1500	1
▲	B-490	<b>FN H L</b>	41.28	15.24	-	-	-	-	M71-76-490	BMP71	M71-R4300	500	1
▲	B-490	<b>FN H L</b>	41.28	15.24	-	-	-	-	THT-155-490-1.5-SC	BBP12, BP-PR+	R7950	1500	1
▲	B-490	<b>FN H L</b>	41.28	15.24	-	-	-	-	THT-155-490-3	BBP12, BP-PR+, IP	R4300, R7950	3000	1
▲	B-492	<b>FN H L</b>	41.28	15.24	-	-	-	-	THT-155-492-3	BBP12, BP-PR+, IP	R6400	3000	1
⊗	B-492	<b>F H L</b>	41.28	15.24	-	9.53	-	-	B33-190-492	BBP33	R6400	1500	1
⊗	B-492	<b>F H L</b>	41.28	15.24	-	9.53	-	-	THT-190-492-3	BBP12, BP-PR+, IP	R6400	3000	1
▲	B-492	<b>FN H L</b>	44.45	25.40	-	-	-	-	M-125-492	BMP51, BMP53	-	180	1
▲	B-490	<b>FN H L</b>	48.26	25.40	-	-	-	-	B33-156-490	BBP33	B30-R4300	1500	1
▲	B-492	<b>FN H L</b>	48.26	25.40	-	-	-	-	B33-156-492	BBP33	B30-R6400	1500	1
▲	B-492	<b>FN H L</b>	48.26	25.40	-	-	-	-	M71-78-492	BMP71	M71-R6400	250	1
▲	B-499	<b>FNA</b>	48.26	25.40	-	-	-	-	M71-78-499	BMP71	M71-R4300	250	1
▲	B-490	<b>FN H L</b>	48.26	25.40	-	-	-	-	THT-156-490-1.5-SC	BBP12, BP-PR+	R7950	1500	1
▲	B-490	<b>FN H L</b>	48.26	25.40	-	-	-	-	THT-156-490-3	BBP12, BP-PR+, IP	R4300, R7950	3000	1
▲	B-492	<b>FN H L</b>	48.26	25.40	-	-	-	-	THT-156-492-1.5-SC	BBP12, BP-PR+	R6400	1500	1
▲	B-492	<b>FN H L</b>	48.26	25.40	-	-	-	-	THT-156-492-3	BBP12, BP-PR+, IP	R6400	3000	1

\*Label is rotated 90° on liner.

>>

# Conical / Large Tube Labels



Labels are shown per vial / tube size and in order of label width.

The background colours in the Order Reference column represent the material colour.

See page 38 for Brady's range of label printers.

Diagram	Material	Special Properties	Label Width A (mm)	Label Height B (mm)	Label Length B (m)	Diameter C (mm)	Printable Area Width PW (mm)	Printable Area Height PH (mm)	Order Reference	Printer Compatibility	Printer Ribbon Series	Labels/Package	Labels per Row
<b>1.0 - 15 ml</b>													
▲	B-492	<b>F N H L</b>	22.86	25.40	-	-	-	-	M-156-492	BMP51, BMP53	-	180	1
<b>1.5 ml</b>													
○	B-499	<b>F N A</b>	12.70	-	4.88	-	-	-	M21-500-499	BMP21-LAB	-	1	1
○	B-499	<b>F N A</b>	12.70	-	4.88	-	-	-	MC-500-499	BMP51, BMP53	-	1	1
○	B-461	<b>F N A H S L</b>	12.70	-	6.40	-	12.70	-	M21-500-461-AW**	BMP21-LAB	-	1	1
○	B-499	<b>F N A</b>	12.70	-	9.10	-	-	-	M71C-500-499	BMP71	M71-R4300	1	1
<b>1.5 - 2.0 ml</b>													
▷	B-461	<b>F N A H S L</b>	15.24	41.28	-	-	15.24	25.40	B33-133-461	BBP33	B30-R4300	1500	3
▷	B-461	<b>F N A H S L</b>	15.24	41.28	-	-	15.24	25.40	THT-133-461-1.5-SC*	BBP12, BP-PR+	R7950	1500	1
▷	B-461	<b>F N A H S L</b>	15.24	41.28	-	-	15.24	25.40	THT-133-461-3*	BBP12, BP-PR+, IP	R4300, R7950	3000	1
▷	B-461	<b>F N A H S L</b>	15.24	66.68	-	-	15.24	25.40	THT-153-461-1.5-SC*	BBP12, BP-PR+	R7950	1500	1
▷	B-461	<b>F N A H S L</b>	15.24	66.68	-	-	15.24	25.40	THT-153-461-3*	BBP12, BP-PR+, IP	R4300, R7950	3000	1
▲	B-492	<b>F N H L</b>	25.40	12.70	-	-	-	-	B33-59-492	BBP33	B30-R6400	2500	1
●	B-430	<b>F A H</b>	25.40	12.70	-	-	-	-	THT-39-430-10	BBP12, BP-PR+, IP	R6000	10000	3
▲	B-492	<b>F N H L</b>	25.40	12.70	-	-	-	-	THT-59-492-10	BBP12, BP-PR+, IP	R6400	10000	1
▲	B-492	<b>F N H L</b>	25.40	12.70	-	-	-	-	THT-59-492-2.5-SC	BBP12, BP-PR+	R6400	2500	1
▼	B-492	<b>F H L</b>	41.28	15.24	-	9.53	-	-	M-95-492	BMP51, BMP53	-	200	1
▲	B-492	<b>F N H L</b>	41.91	12.70	-	-	-	-	M-124-492	BMP51, BMP53	-	180	1
<b>2.0 - 4.0 ml</b>													
▷	B-461	<b>F N A H S L</b>	15.24	48.26	-	-	15.24	40.00	B33-638-461*	BBP33	B30-R4300	2000	1
▷	B-461	<b>F N A H S L</b>	15.24	48.26	-	-	15.24	40.00	BPT-638-461*	BBP12, BP-PR+	R7950	2000	1
▷	B-461	<b>F N A H S L</b>	15.24	48.26	-	-	15.24	40.00	M71-119-461	BMP71	M71-R6200	500	1
<b>2.0 - 50.0 ml</b>													
▲	B-427	<b>F N S</b>	19.05	-	4.30	-	9.53	-	M21-750-427	BMP21-LAB	-	1	-
○	B-499	<b>F N A</b>	19.05	-	4.88	-	-	-	M21-750-499	BMP21-LAB	-	1	1
○	B-499	<b>F N A</b>	19.05	-	4.88	-	-	-	MC-750-499	BMP51, BMP53	-	1	1
○	B-461	<b>F N A H S L</b>	19.05	-	6.40	-	19.05	-	M21-750-461-AW**	BMP21-LAB	-	1	1
▲	B-427	<b>F N S</b>	19.05	-	7.62	-	9.53	-	MC-750-427	BMP51, BMP53	-	1	1
▲	B-427	<b>F N S</b>	25.40	-	4.30	-	9.53	-	M21-1000-427	BMP21-LAB	-	1	-
○	B-499	<b>F N A</b>	25.40	-	4.88	-	-	-	MC-1000-499	BMP51, BMP53	-	1	1
▲	B-427	<b>F N S</b>	25.40	-	7.62	-	9.53	-	MC-1000-427	BMP51, BMP53	-	1	1
○	B-461	<b>F N A H S L</b>	25.40	-	7.62	-	25.40	-	MC-1000-461-AW**	BMP51, BMP53	-	1	1
○	B-499	<b>F N A</b>	25.40	-	9.10	-	-	-	M71C-1000-499	BMP71	M71-R4300	1	1
<b>4.0 - 8.0 ml</b>													
●	B-499	<b>F N A</b>	25.40	66.68	-	-	-	-	B33-625-499	BBP33	B30-R6000HF	1500	3
●	B-499	<b>F N A</b>	25.40	66.68	-	-	-	-	BPT-625-499	BBP12, BP-PR+	R7950	1500	3
<b>4.0 - 50.0 ml</b>													
▲	B-427	<b>F N S</b>	30.48	-	4.30	-	12.70	-	M21-1250-427	BMP21-LAB	-	1	-
▲	B-427	<b>F N S</b>	31.75	-	7.62	-	12.70	-	MC-1250-427	BMP51, BMP53	-	1	1
○	B-461	<b>F N A H S L</b>	31.75	-	7.62	-	31.75	-	MC-1250-461-AW**	BMP51, BMP53	-	1	1
▷	B-461	<b>F N A H S L</b>	34.93	45.72	-	-	34.93	40.00	B33-632-461*	BBP33	B30-R4300	1500	1
▷	B-461	<b>F N A H S L</b>	34.93	45.72	-	-	34.93	40.00	BPT-632-461*	BBP12, BP-PR+	R7950	2000	1
<b>5.0 - 50.0 ml</b>													
▲	B-427	<b>F N S</b>	38.10	-	4.30	-	12.70	-	M21-1500-427	BMP21-LAB	-	1	-
▲	B-427	<b>F N S</b>	38.10	-	7.62	-	12.70	-	MC-1500-427	BMP51, BMP53	-	1	1
○	B-499	<b>F N A</b>	48.26	-	9.10	-	-	-	M71C-1900-499	BMP71	M71-R4300	1	1

\*Label is rotated 90° on liner. \*\*AW = All White / no transparent area.

>>>

**F** Freezer environment **N** Liquid nitrogen environment **A** Autoclave environment **H** Hot water bath (100°C) **S** Self-laminating label **L** Low-profile (extremely thin) label **R** Removable

# Conical / Large Tube Labels

Diagram

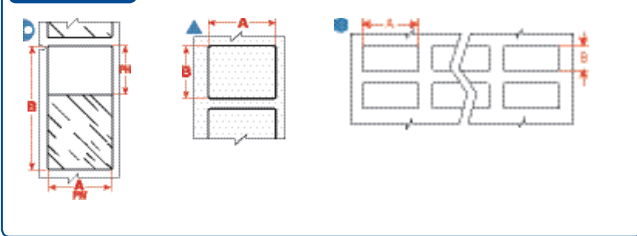

The background colours in the Order Reference column represent the material colour.

See page 38 for Brady's range of label printers.

Labels are shown per vial / tube size and in order of label width.

Diagram	Material	Special Properties	Label Width A (mm)	Label Height B (mm)	Label Length B (m)	Diameter C (mm)	Printable Area Width PW (mm)	Printable Area Height PH (mm)	Order Reference	Printer Compatibility	Printer Ribbon Series	Labels/Package	Labels per Row
<b>12.0 - 14.0 ml</b>													
	B-461	<b>F N A H S L</b>	38.10	95.25	-	-	38.10	31.75	M-119-461	BMP51, BMP53	-	80	1
<b>12.0 - 24.0 ml</b>													
	B-492	<b>F N H L</b>	25.40	48.26	-	-	-	-	M-78-492	BMP51, BMP53	-	100	1
	B-498	<b>F R</b>	38.10	12.70	-	-	-	-	BM71-29-498	BMP71	M71-R6200	5000	1
	B-498	<b>F R</b>	38.10	12.70	-	-	-	-	M71-29-498	BMP71	M71-R6200	500	1
	B-499	<b>F N A</b>	38.10	12.70	-	-	-	-	M71-29-499	BMP71	M71-R4300	500	1
	B-499	<b>F N A</b>	38.10	31.75	-	-	-	-	M-132-499	BMP51, BMP53	-	160	1
<b>12.0 - 50.0 ml</b>													
	B-461	<b>F N A H S L</b>	25.40	133.35	-	-	25.40	38.10	B33-139-461	BBP33	B30-R4300	650	2
	B-461	<b>F N A H S L</b>	25.40	133.35	-	-	25.40	38.10	THT-139-461-2	BBP12, BP-PR+, IP	R4300, R7950	2000	2
<b>14.0 - 15.0 ml</b>													
	B-490	<b>F N H L</b>	38.10	55.88	-	-	-	-	M-113-490	BMP51, BMP53	-	140	1
	B-461	<b>F N A H S L</b>	38.10	57.15	-	-	38.10	31.75	M-129-461	BMP51, BMP53	-	140	1
	B-427	<b>F N S</b>	38.10	63.50	-	-	38.10	19.05	B33-517-427	BBP33	B30-R4300	1000	2
	B-427	<b>F N S</b>	38.10	63.50	-	-	38.10	19.05	BPT-517-427	BBP12, BP-PR+	R7950	2000	2
	B-427	<b>F N S</b>	38.10	63.50	-	-	38.10	19.05	M-116-427	BMP51, BMP53	-	80	1
	B-490	<b>F N H L</b>	55.88	38.10	-	-	-	-	THT-157-490-1.5-SC	BBP12, BP-PR+	R7950	1500	1
	B-490	<b>F N H L</b>	55.88	38.10	-	-	-	-	THT-157-490-3	BBP12, BP-PR+, IP	R4300, R7950	3000	1
<b>15.0 - 50.0 ml</b>													
	B-461	<b>F N A H S L</b>	19.05	38.10	-	-	19.05	33.00	BPT-629-461*	BBP12, BP-PR+	R7950	2500	2
	B-499	<b>F N A</b>	20.32	36.50	-	-	-	-	B33-165-499	BBP33	B30-R6000HF	2500	4
	B-498	<b>F R</b>	20.32	36.50	-	-	-	-	B33-95-498	BBP33	B30-R6200	2300	3
	B-498	<b>F R</b>	20.32	36.50	-	-	20.32	36.50	THT-95-498-5	BBP12, BP-PR+, IP	R4300, R7950	5000	3
	B-499	<b>F N A</b>	20.32	36.50	-	-	36.50	20.32	THT-69-499-3	BBP12, BP-PR+, IP	R4900	3000	2
	B-499	<b>F N A</b>	22.86	38.10	-	-	-	-	BPT-618-499	BBP12, BP-PR+	R7950	3000	3
	B-499	<b>F N A</b>	25.40	36.50	-	-	-	-	B33-621-499	BBP33	B30-R6000HF	3000	3
	B-498	<b>F R</b>	25.40	36.50	-	-	-	-	BPT-621-498	BBP12, BP-PR+	R7950	3000	3
	B-499	<b>F N A</b>	25.40	36.50	-	-	-	-	BPT-621-499	BBP12, BP-PR+	R7950	3000	3
	B-498	<b>F R</b>	25.40	36.50	-	-	36.50	25.40	THT-89-498-5	BBP12, BP-PR+, IP	R4300, R7950	5000	3
	B-461	<b>F N A H S L</b>	25.40	66.68	-	-	25.40	25.40	B33-276-461	BBP33	B30-R4300	1500	2
	B-461	<b>F N A H S L</b>	38.10	88.90	-	-	38.10	31.75	B33-134-461*	BBP33	B30-R4300	1000	1
	B-461	<b>F N A H S L</b>	38.10	88.90	-	-	38.10	31.75	THT-134-461-3*	BBP12, BP-PR+, IP	R4300, R7950	3000	1
	B-461	<b>F N A H S L</b>	48.26	25.40	-	-	48.26	25.40	B33-636-461AW**	BBP33	B30-R4300	2000	1
	B-461	<b>F N A H S L</b>	48.26	25.40	-	-	48.26	25.40	BPT-636-461-AW**	BBP12, BP-PR+	R7950	2000	1
	B-427	<b>F N S</b>	55.88	38.10	-	-	55.88	38.10	B33-640-427AW**	BBP33	B30-R4300	1500	1
	B-427	<b>F N S</b>	55.88	38.10	-	-	55.88	38.10	BPT-640-427-AW**	BBP12, BP-PR+	R7950	2000	1
	B-461	<b>F N A H L</b>	57.15	19.05	-	-	57.15	19.05	B33-642-461AW**	BBP33	B30-R4300	2000	1
	B-461	<b>F N A H S L</b>	57.15	19.05	-	-	57.15	19.05	BPT-642-461-AW**	BBP12, BP-PR+	R7950	2000	1
	B-427	<b>F N S</b>	66.68	25.40	-	-	66.68	25.40	B33-648-427AW**	BBP33	B30-R4300	1500	1
	B-427	<b>F N S</b>	66.68	25.40	-	-	66.68	25.40	BPT-648-427-AW**	BBP12, BP-PR+	R7950	2000	1
	B-461	<b>F N A H S L</b>	88.90	38.10	-	-	88.90	38.10	B33-650-461AW**	BBP33	B30-R4300	2000	1
	B-461	<b>F N A H S L</b>	88.90	38.10	-	-	88.90	38.10	BPT-650-461-AW**	BBP12, BP-PR+	R7950	2000	1

\*Label is rotated 90° on liner. \*\*AW = All White / no transparent area.

>>

# Conical / Large Tube Labels

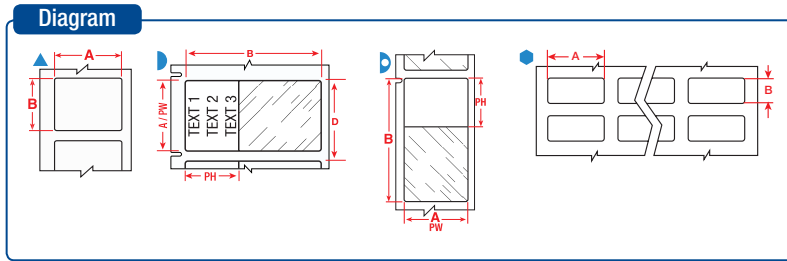

The background colours in the Order Reference column represent the material colour.

See page 38 for Brady's range of label printers.

Labels are shown per vial / tube size and in order of label width.

Diagram	Material	Special Properties	Label Width A (mm)	Label Height B (mm)	Label Length B (m)	Diameter C (mm)	Printable Area Width PW (mm)	Printable Area Height PH (mm)	Order Reference	Printer Compatibility	Printer Ribbon Series	Labels/Package	Labels per Row
<b>50.0 ml</b>													
	B-423	<b>F AH</b>	12.70	12.70	-	-	-	-	BM71-7-423	BMP71	M71-R6000HF	5000	1
	B-423	<b>F AH</b>	12.70	12.70	-	-	-	-	M71-7-423	BMP71	M71-R6000HF	500	1
	B-427	<b>FN S</b>	19.05	38.10	-	-	19.05	12.70	BM71-30-427	BMP71	M71-R4300	2500	1
	B-427	<b>FN S</b>	19.05	38.10	-	-	19.05	12.70	M71-30-427	BMP71	M71-R4300	250	1
	B-427	<b>FN S</b>	19.05	38.10	-	-	19.05	12.70	M-90-427	BMP51, BMP53	-	180	1
	B-461	<b>FNAHSL</b>	19.05	38.10	-	-	19.05	33.02	B33-629-461*	BBP33	B30-R4300	2500	2
	B-492	<b>FN H L</b>	22.86	25.40	-	-	-	-	THT-180-492-3	BBP12, BP-PR+, IP	R6400	3000	1
	B-423	<b>F AH</b>	25.40	4.75	-	-	-	-	M71-14-423	BMP71	M71-R6000HF	750	1
	B-423	<b>F AH</b>	25.40	4.75	-	-	-	-	THT-41-423-10	BBP12, BP-PR+, IP	R6000HF	10000	3
	B-423	<b>F AH</b>	25.40	6.35	-	-	-	-	THT-51-423-10	BBP12, BP-PR+, IP	R6000HF	10000	3
	B-423	<b>F AH</b>	25.40	6.99	-	-	-	-	M71-15-423	BMP71	M71-R6000HF	750	1
	B-423	<b>F AH</b>	25.40	12.70	-	-	-	-	M71-17-423	BMP71	M71-R6000HF	500	1
	B-492	<b>FN H L</b>	25.40	12.70	-	-	-	-	M71-17-492	BMP71	M71-R6400	500	1
	B-498	<b>F R</b>	25.40	12.70	-	-	-	-	M71-17-498	BMP71	M71-R6200	500	1
	B-492	<b>FN H L</b>	25.40	25.40	-	-	-	-	B33-179-492	BBP33	B30-R6400	1900	1
	B-492	<b>FN H L</b>	25.40	25.40	-	-	-	-	THT-179-492-2.5-SC	BBP12, BP-PR+	R6400	2500	1
	B-492	<b>FN H L</b>	25.40	25.40	-	-	-	-	THT-179-492-3	BBP12, BP-PR+, IP	R6400	3000	1
	B-427	<b>FN S</b>	25.40	38.10	-	-	25.40	12.70	BM71-31-427	BMP71	M71-R4300	2500	1
	B-427	<b>FN S</b>	25.40	38.10	-	-	25.40	12.70	M71-31-427	BMP71	M71-R4300	250	1
	B-461	<b>FNAHSL</b>	25.40	38.10	-	-	25.40	12.70	M71-31-461	BMP71	M71-R6200	250	1
	B-427	<b>FN S</b>	25.40	38.10	-	-	25.40	12.70	M-91-427	BMP51, BMP53	-	180	1
	B-499	<b>FNA</b>	25.40	48.26	-	-	-	-	M-128-499	BMP51, BMP53	-	100	1
	B-499	<b>FNA</b>	25.40	50.80	-	-	-	-	B33-137-499	BBP33	B30-R6000HF	1100	1
	B-423	<b>F AH</b>	25.40	50.80	-	-	-	-	BM71-20-423	BMP71	M71-R6000HF	1000	1
	B-423	<b>F AH</b>	25.40	50.80	-	-	-	-	M71-20-423	BMP71	M71-R6000HF	100	1
	B-427	<b>FN S</b>	25.40	50.80	-	-	25.40	50.80	THT-137-427-3-AW**	BBP12, BP-PR+, IP	R4300, R7950	3000	1
	B-499	<b>FNA</b>	25.40	63.50	-	-	-	-	M71-21-499	BMP71	M71-R4300	100	1
	B-423	<b>F AH</b>	25.40	76.20	-	-	-	-	M71-22-423	BMP71	M71-R6000HF	100	1
	B-499	<b>FNA</b>	38.10	19.05	-	-	-	-	B33-136-499	BBP33	B30-R6000HF	1500	1
	B-499	<b>FNA</b>	38.10	19.05	-	-	-	-	M71-30-499	BMP71	M71-R4300	250	1
	B-499	<b>FNA</b>	38.10	19.05	-	-	-	-	THT-136-499-1.5-SC	BBP12, BP-PR+	R7950	1500	1
	B-499	<b>FNA</b>	38.10	19.05	-	-	-	-	THT-136-499-3	BBP12, BP-PR+, IP	R4900	3000	1
	B-427	<b>FN S</b>	38.10	19.05	-	-	38.10	19.05	B33-135-427AW**	BBP33	B30-R4300	1500	1
	B-427	<b>FN S</b>	38.10	19.05	-	-	38.10	19.05	M71-30-427-AW**	BMP71	M71-R4300	250	1
	B-427	<b>FN S</b>	38.10	19.05	-	-	38.10	19.05	THT-135-427-3-AW**	BBP12, BP-PR+, IP	R4300, R7950	3000	1
	B-423	<b>F AH</b>	38.10	25.40	-	-	-	-	M71-31-423	BMP71	M71-R6000HF	250	1
	B-498	<b>F R</b>	38.10	25.40	-	-	-	-	M71-31-498	BMP71	M71-R6200	250	1
	B-499	<b>FNA</b>	38.10	25.40	-	-	-	-	M71-31-499	BMP71	M71-R4300	250	1
	B-490	<b>FN H L</b>	38.10	98.42	-	-	-	-	M-114-490	BMP51, BMP53	-	80	1
	B-490	<b>FN H L</b>	50.80	6.35	-	-	-	-	B33-151-490	BBP33	B30-R4300	2500	1
	B-499	<b>FNA</b>	50.80	25.40	-	-	-	-	THT-137-499-1.5-SC	BBP12, BP-PR+	R7950	1500	1
	B-499	<b>FNA</b>	50.80	25.40	-	-	-	-	THT-137-499-3	BBP12, BP-PR+, IP	R4900	3000	1
	B-427	<b>FN S</b>	50.80	25.40	-	-	50.80	25.40	B33-137-427AW**	BBP33	B30-R4300	1500	1
	B-490	<b>FN H L</b>	95.25	38.10	-	-	-	-	THT-158-490-1.5-SC	BBP12, BP-PR+	R7950	1500	1
	B-490	<b>FN H L</b>	95.25	38.10	-	-	-	-	THT-158-490-3	BBP12, BP-PR+, IP	R4300, R7950	3000	1

\*Label is rotated 90° on liner. \*\*AW = All White / no transparent area.

**F** Freezer environment **N** Liquid nitrogen environment **A** Autoclave environment **H** Hot water bath (100°C) **S** Self-laminating label **L** Low-profile (extremely thin) label **R** Removable



## SLIDE LABELS

Brady offers labels specifically designed to identify slides and to resist exposure to harsh chemicals during the slide staining process. They perform well in the hematoxylin and eosin slide staining process and offer superior chemical resistance also useful in other laboratory contexts.

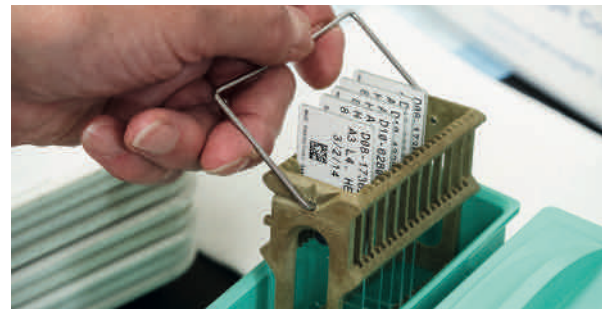

### Diagram

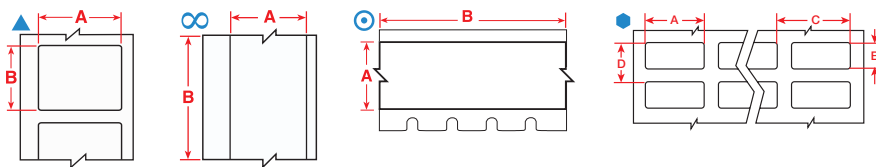

- F** Freezer environment
- N** Liquid nitrogen environment
- A** Autoclave environment
- H** Hot water bath (100°C)
- S** Self-laminating label
- L** Low-profile (extremely thin) label
- R** Removable

Labels are shown in order of label width.

The background colours in the Order Reference column represent the material colour.

See page 38 for Brady's range of label printers.

Diagram	Material	Special Properties	Label Width A (mm)	Label Height B (mm)	Label Length B (m)	Order Reference	Printer Compatibility	Printer Ribbon Series	Labels/Package	Labels per Row
▲	B-488	<b>F</b> <b>A</b>	6.35	48.26	–	M-81-488	BMP51, BMP53	–	160	1
⊙	B-488	<b>F</b> <b>A</b>	9.53	–	6.40	M21-375-488	BMP21-LAB	–	1	1
⊙	B-488	<b>F</b> <b>A</b>	12.70	–	6.40	M21-500-488	BMP21-LAB	–	1	1
⊙	B-488	<b>F</b> <b>A</b>	19.05	–	6.40	M21-750-488	BMP21-LAB	–	1	1
▲	B-488	<b>F</b> <b>A</b>	19.05	22.86	–	M71-80-488	BMP71	M71-R4300	250	1
▲	B-481	<b>F</b> <b>H</b>	22.86	9.53	–	B33-195-481	BBP33	B30-R6400	3000	1
▲	B-481	<b>F</b> <b>H</b>	22.86	9.53	–	THT-195-481-3	BBP12, BP-PR+, IP	R6400	3000	1
▲	B-481	<b>F</b> <b>H</b>	22.86	19.05	–	B33-194-481	BBP33	B30-R6400	2000	1
●	B-488	<b>F</b> <b>A</b>	22.86	19.05	–	B33-616-488	BBP33	B30-R4300	3000	3
●	B-488	<b>F</b> <b>A</b>	22.86	19.05	–	BPT-616-488	BBP12, BP-PR+	R7950	3000	3
▲	B-481	<b>F</b> <b>H</b>	22.86	19.05	–	BPT-194-481	BBP12, BP-PR+	R6400	2500	1
▲	B-481	<b>F</b> <b>H</b>	22.86	19.05	–	M-194-481	BMP51, BMP53	–	320	1
▲	B-481	<b>F</b> <b>H</b>	22.86	19.05	–	THT-194-481-3	BBP12, BP-PR+, IP	R6400	3000	1
●	B-488	<b>F</b> <b>A</b>	22.86	19.05	–	THT-140-488-3	BBP12, BP-PR+, IP	R4300, R7950	3000	2
●	B-488	<b>F</b> <b>A</b>	22.86	19.05	–	THT-140-488-1.5-SC	BBP12, BP-PR+	R7950	1500	2
●	B-488	<b>F</b> <b>A</b>	22.86	22.86	–	B33-617-488	BBP33	B30-R4300	3000	3
●	B-488	<b>F</b> <b>A</b>	22.86	22.86	–	BPT-617-488	BBP12, BP-PR+	R7950	3000	3
▲	B-481	<b>F</b> <b>H</b>	22.86	22.86	–	BPT-164-481	BBP12, BP-PR+	R6400	2500	1
▲	B-481	<b>F</b> <b>H</b>	22.86	22.86	–	M-97-481	BMP51, BMP53	–	280	1
▲	B-488	<b>F</b> <b>A</b>	22.86	22.86	–	M-97-488	BMP51, BMP53	–	180	1
▲	B-481	<b>F</b> <b>H</b>	22.86	22.86	–	M71-97-481	BMP71	M71-R6400	250	1
▲	B-488	<b>F</b> <b>A</b>	22.86	22.86	–	M71-97-488	BMP71	M71-R4300	250	1
●	B-481	<b>F</b> <b>H</b>	22.86	22.86	–	THT-207-481-2.5-SC	BBP12, BP-PR+	R6400	2500	4
▲	B-481	<b>F</b> <b>H</b>	22.86	22.86	–	THT-164-481-3	BBP12, BP-PR+, IP	R6400	3000	1
▲	B-488	<b>F</b> <b>A</b>	22.86	22.86	–	THT-164-488-1	BBP12, BP-PR+, IP	R4300, R7950	1000	1
●	B-481	<b>F</b> <b>H</b>	22.86	22.86	–	THT-141-481-3	BBP12, BP-PR+, IP	R6400	3000	2
●	B-488	<b>F</b> <b>A</b>	22.86	22.86	–	THT-141-488-3	BBP12, BP-PR+, IP	R4300, R7950	3000	2
●	B-481	<b>F</b> <b>H</b>	22.90	22.90	–	THT-141-481-1.5-SC	BBP12, BP-PR+	R6400	1500	2
▲	B-481	<b>F</b> <b>H</b>	25.40	9.53	–	M-195-481	BMP51, BMP53	–	320	1
▲	B-488	<b>F</b> <b>A</b>	48.26	6.35	–	B33-635-488	BBP33	B30-R4300	2000	1
▲	B-488	<b>F</b> <b>A</b>	50.80	6.35	–	THT-15-488-2.5	BBP12, BP-PR+, IP	R7950	2500	1
▲	B-481	<b>F</b> <b>H</b>	63.50	5.08	–	THT-142-481-2.5	BBP12, BP-PR+, IP	R6400	2500	1
▲	B-481	<b>F</b> <b>H</b>	63.50	5.08	–	THT-142-481-2.5-SC	BBP12, BP-PR+	R6400	2500	1

**F** Freezer environment **N** Liquid nitrogen environment **A** Autoclave environment **H** Hot water bath (100°C) **S** Self-laminating label **L** Low-profile (extremely thin) label **R** Removable



## TISSUE CASSETTE LABELS

Specifically designed to identify tissue cassettes, Brady's B-482 label withstands a temperature range from -80°C to 121°C and offers superior resistance to chemicals used in tissue processing enabling it to retain barcode legibility. The label must be used in combination with Brady's BSP™31 Label Attachment System for pre-process tissue cassette identification and complements the use of StainerBondz slide labels as part of a complete histology process.

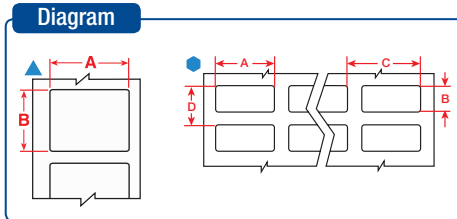

- F** Freezer environment
- N** Liquid nitrogen environment
- A** Autoclave environment
- H** Hot water bath (100°C)
- S** Self-laminating label
- L** Low-profile (extremely thin) label
- R** Removable

Labels are shown in order of label width.

The background colours in the Order Reference column represent the material colour.

See page 38 for Brady's range of label printers.

Diagram	Material	Special Properties	Label Width A (mm)	Label Height B (mm)	Order Reference	Printer Compatibility	Printer Ribbon Series	Labels/Package	Labels per Row
▲	B-482	<b>F</b> <b>H</b>	26.67	6.35	B33-199-482	BBP33	B30-R6400	3000	1
▲	B-482	<b>F</b> <b>H</b>	26.67	6.35	M-127-482	BMP51, BMP53	—	360	1
▲	B-482	<b>F</b> <b>H</b>	26.67	6.35	THT-199-482-3	BBP12, BP-PR Plus, IP	R6400	3000	1
▲	B-482	<b>F</b> <b>H</b>	26.67	6.35	THT-199-482-3-SC	BBP12, BP-PR Plus	R6400	3000	1
▲	B-482	<b>F</b> <b>H</b>	26.67	7.95	B33-213-482	BBP33	B30-R6400	3000	1
▲	B-482	<b>F</b> <b>H</b>	26.67	7.95	THT-213-482-3	BBP12, BP-PR Plus, IP	R6400	3000	1
▲	B-482	<b>F</b> <b>H</b>	26.67	7.95	THT-213-482-3-SC	BBP12, BP-PR Plus, IP	R6400	3000	1

### i



### Specimen Labelling Solution for Histology and Anatomic Pathology

As part of Brady's complete laboratory labelling solution, our combination of the B-482 Tissue Cassette label and the BSP™31 Label Attachment System, **ensures your specimen will stick throughout processing, embedding and sectioning.** See page 47 for more information on the BSP31.

### i



### B-498 Re-Identify Tissue Cassettes Labels

Tissue cassettes are often re-identified when labs collect samples from various biorepositories. Typically, each laboratory has its own unique way of identifying samples, which creates a need to re-identify samples in a common way.

Brady B-498 post-process labels offer customers the optimal way to organise these specimens and conduct further studies. These labels can be applied directly onto the cassettes, on pure paraffin wax and on top of another label or identifier.

This is not the same as Brady's B-482 tissue cassette solution. **B-498 Re-identify labels are applied after processing and are never used with the BSP31 label attachment system.**

Diagram	Material	Special Properties	Label Width A (mm)	Label Height B (mm)	Order Reference	Printer Compatibility	Printer Ribbon Series	Labels/Package	Labels per Row
●	B-498	<b>F</b> <b>R</b>	19.05	6.35	B33-1-498	BBP33	B30-R6200	5000	4
▲	B-498	<b>F</b> <b>R</b>	19.05	6.35	M71-10-498	BMP71	M71-R6200	750	1
▲	B-498	<b>F</b> <b>R</b>	19.05	6.35	THT-252-498-3	BBP12, BP-PR Plus, IP	R4300, R7950	3000	1
▲	B-498	<b>F</b> <b>R</b>	19.05	6.35	THT-252-498-3-SC	BBP12, BP-PR Plus	R7950	3000	1
●	B-498	<b>F</b> <b>R</b>	19.05	6.35	THT-1-498-10	BBP12, BP-PR Plus, IP	R4300, R7950	10000	4
▲	B-498	<b>F</b> <b>R</b>	19.05	12.70	M-11-498	BMP51, BMP53	—	220	1
▲	B-498	<b>F</b> <b>R</b>	19.05	19.05	THT-254-498-3	BBP12, BP-PR Plus, IP	R4300, R7950	3000	1
▲	B-498	<b>F</b> <b>R</b>	19.05	19.05	THT-254-498-1.5-SC	BBP12, BP-PR Plus	R7950	1500	1
▲	B-498	<b>F</b> <b>R</b>	25.40	4.75	THT-253-498-3	BBP12, BP-PR Plus, IP	R4300, R7950	3000	1
▲	B-498	<b>F</b> <b>R</b>	25.40	4.75	THT-253-498-3-SC	BBP12, BP-PR Plus	R7950	3000	1

- F** Freezer environment
- N** Liquid nitrogen environment
- A** Autoclave environment
- H** Hot water bath (100°C)
- S** Self-laminating label
- L** Low-profile (extremely thin) label
- R** Removable

## STRAW AND ROD LABELS

Brady offers a range of labels designed to fit the small surface area of straws and rods and will withstand long-term storage.

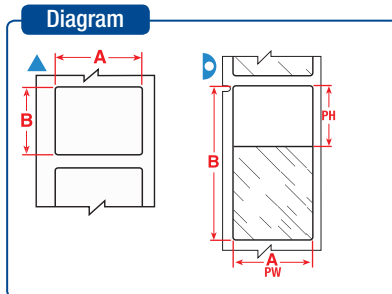

Labels are shown per straw size and in order of label width.

The background colours in the Order Reference column represent the material colour.

See page 38 for Brady's range of label printers.

Diagram	Material	Special Properties	Label Width A (mm)	Label Height B (mm)	Printable Area Width PW (mm)	Printable Area Height PH (mm)	Order Reference	Printer Compatibility	Printer Ribbon Series	Labels/Package	Labels per Row	
<b>0.25 ml Straw</b>												
▲	B-427	<b>F N S</b>	20.00	20.00	20.00	20.00	BPTLAB-35-427-YL	BBP12, BP-PR+	R7950	1000	1	
▷	B-427	<b>F N S</b>	25.40	25.40	25.40	9.53	B33-116-427	BBP33	B30-R4300	2500	2	
▷	B-427	<b>F N S</b>	25.40	25.40	25.40	9.53	B33-211-427	BBP33	B30-R4300	3000	3	
▷	B-427	<b>F N S</b>	25.40	25.40	25.40	9.53	BM71-19-427	BMP71	M71-R4300	2500	1	
▷	B-427	<b>F N S</b>	25.40	25.40	25.40	9.53	BPT-211-427	BBP12, BP-PR+	R7950	3000	3	
▷	B-427	<b>F N S</b>	25.40	25.40	25.40	9.53	M-49-427	BMP51, BMP53	–	260	1	
▷	B-427	<b>F N S</b>	25.40	25.40	25.40	9.53	M71-19-427	BMP71	M71-R4300	250	1	
▷	B-461	<b>F N A H S L</b>	25.40	25.40	25.40	9.53	M71-19-461	BMP71	M71-R4300	250	1	
▷	B-427	<b>F N S</b>	25.40	25.40	25.40	9.53	M71-19-427-YL	BMP71	M71-R4300	250	1	
▷	B-427	<b>F N S</b>	25.40	25.40	25.40	9.53	THT-116-427-5	BBP12, BP-PR+, IP	R4300, R7950	5000	2	
▷	B-427	<b>F N S</b>	44.45	25.40	44.45	9.53	B33-120-427	BBP33	B30-R4300	1250	1	
▷	B-427	<b>F N S</b>	44.45	25.40	44.45	9.53	M-133-427	BMP51, BMP53	–	140	1	
▷	B-427	<b>F N S</b>	44.45	38.10	44.45	12.70	B33-121-427	BBP33	B30-R4300	1000	1	
▷	B-427	<b>F N S</b>	44.45	38.10	44.45	12.70	M71-88-427	BMP71	M71-R4300	250	1	
<b>0.50 ml Straw</b>												
▷	B-427	<b>F N S</b>	25.40	63.50	25.40	19.05	BM71-21-427	BMP71	M71-R4300	1000	1	
▷	B-427	<b>F N S</b>	25.40	63.50	25.40	19.05	B33-511-427	BBP33	B30-R4300	1500	3	
▷	B-427	<b>F N S</b>	25.40	63.50	25.40	19.05	BPT-511-427	BBP12, BP-PR+	R7950	3000	3	
▷	B-427	<b>F N S</b>	25.40	63.50	25.40	19.05	M-51-427	BMP51, BMP53	–	110	1	
▷	B-427	<b>F N S</b>	25.40	63.50	25.40	19.05	M71-21-427	BMP71	M71-R4300	100	1	
▷	B-427	<b>F N S</b>	25.40	63.50	25.40	19.05	M71-21-427-YL	BMP71	M71-R4300	100	1	
▷	B-427	<b>F N S</b>	44.45	38.10	44.45	12.70	M-134-427	BMP51, BMP53	–	140	1	
<b>Straw Rod</b>												
▲	B-427	<b>F N S</b>	27.94	6.35	27.94	6.35	M-135-427-AW**	BMP51, BMP53	–	240	1	
▷	B-461	<b>F N A H S L</b>	6.35	27.94	6.35	22.00	BPT-627-461*	BBP12, BP-PR+	R7950	1000	1	

\*Label is rotated 90° on liner. \*\*AW = All White / no transparent area.

### Part number explanation

Most Brady references for printable labels follow the same three-part format: The first code indicates the technology, the second part is a number indicating the label size (where applicable) and the third part indicates the Brady material (where applicable).

## M71-73-461

BMP71  
Technology

Label size  
code

Material  
(B-number)

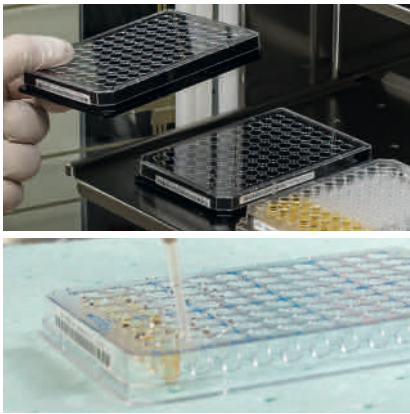

## WELL PLATE LABELS

When total tracking of all sample collections is required then Brady has a solution for Well plate identification. Our well plate labels guarantee crystal clear text and barcoding for most lab environments.

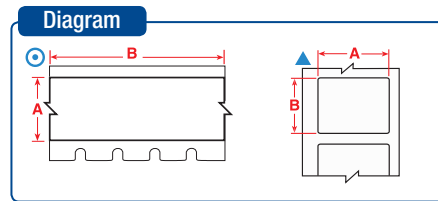

- F** Freezer environment
- N** Liquid nitrogen environment
- A** Autoclave environment
- H** Hot water bath (100°C)
- S** Self-laminating label
- L** Low-profile (extremely thin) label
- R** Removable

Labels are shown in order of label width.

The background colours in the Order Reference column represent the material colour.

See page 38 for Brady's range of label printers.

Diagram	Material	Special Properties	Label Width A (mm)	Label Height B (mm)	Label Length B (m)	Order Reference	Printer Compatibility	Printer Ribbon Series	Labels/Package	Labels per Row
⊙	B-423	<b>F A H</b>	6.35	-	6.40	M21-250-423	BMP21-LAB	-	1	1
⊙	B-430	<b>F A H</b>	6.35	-	6.40	M21-250-430	BMP21-LAB	-	1	1
⊙	B-595	<b>F</b>	6.35	-	6.40	M21-250-595-WT	BMP21-LAB	-	1	1
⊙	B-430	<b>F A H</b>	6.35	-	6.40	M21-250-430-WT-CL	BMP21-LAB	-	1	1
⊙	B-595	<b>F</b>	6.35	-	6.40	M21-250-595-YL	BMP21-LAB	-	1	1
▲	B-488	<b>F A</b>	6.35	48.26	-	M-81-488	BMP51, BMP53	-	160	1
▲	B-423	<b>F A H</b>	6.35	50.80	-	M71-2-423	BMP71	M71-R6000HF	100	1
⊙	B-499	<b>F N A</b>	9.53	-	4.88	M21-375-499	BMP21-LAB	-	1	1
⊙	B-499	<b>F N A</b>	9.53	-	4.88	MC-375-499	BMP51, BMP53	-	1	1
⊙	B-423	<b>F A H</b>	9.53	-	6.40	M21-375-423	BMP21-LAB	-	1	1
⊙	B-430	<b>F A H</b>	9.53	-	6.40	M21-375-430	BMP21-LAB	-	1	1
⊙	B-488	<b>F A</b>	9.53	-	6.40	M21-375-488	BMP21-LAB	-	1	1
⊙	B-7425	<b>F N A H</b>	9.53	-	6.40	M21-375-7425	BMP21-LAB	-	1	1
⊙	B-595	<b>F</b>	9.53	-	6.40	M21-375-595-BK	BMP21-LAB	-	1	1
⊙	B-595	<b>F</b>	9.53	-	6.40	M21-375-595-BL	BMP21-LAB	-	1	1
⊙	B-595	<b>F</b>	9.53	-	6.40	M21-375-595-GN	BMP21-LAB	-	1	1
⊙	B-595	<b>F</b>	9.53	-	6.40	M21-375-595-OR	BMP21-LAB	-	1	1
⊙	B-595	<b>F</b>	9.53	-	6.40	M21-375-595-RD	BMP21-LAB	-	1	1
⊙	B-595	<b>F</b>	9.53	-	6.40	M21-375-595-WT	BMP21-LAB	-	1	1
⊙	B-430	<b>F A H</b>	9.53	-	6.40	M21-375-430-WT-CL	BMP21-LAB	-	1	1
⊙	B-595	<b>F</b>	9.53	-	6.40	M21-375-595-YL	BMP21-LAB	-	1	1
⊙	B-595	<b>F</b>	9.53	-	7.62	MC-375-595-WT-BK	BMP51, BMP53	-	1	1
⊙	B-595	<b>F</b>	9.53	-	7.62	MC-375-595-YL-BK	BMP51, BMP53	-	1	1
⊙	B-430	<b>F A H</b>	9.53	-	15.24	M71C-375-430	BMP71	M71-R6000HF	1	1
⊙	B-499	<b>F N A</b>	12.70	-	4.88	M21-500-499	BMP21-LAB	-	1	1
⊙	B-499	<b>F N A</b>	12.70	-	4.88	MC-500-499	BMP51, BMP53	-	1	1
⊙	B-595	<b>F</b>	12.70	-	6.10	MC-500-595-CL-BK	BMP51, BMP53	-	1	1
⊙	B-595	<b>F</b>	12.70	-	6.10	MC-500-595-CL-WT	BMP51, BMP53	-	1	1
⊙	B-423	<b>F A H</b>	12.70	-	6.40	M21-500-423	BMP21-LAB	-	1	1
⊙	B-430	<b>F A H</b>	12.70	-	6.40	M21-500-430	BMP21-LAB	-	1	1
⊙	B-488	<b>F A</b>	12.70	-	6.40	M21-500-488	BMP21-LAB	-	1	1
⊙	B-7425	<b>F N A H</b>	12.70	-	6.40	M21-500-7425	BMP21-LAB	-	1	1
⊙	B-595	<b>F</b>	12.70	-	6.40	M21-500-595-BK	BMP21-LAB	-	1	1
⊙	B-595	<b>F</b>	12.70	-	6.40	M21-500-595-BL	BMP21-LAB	-	1	1
⊙	B-595	<b>F</b>	12.70	-	6.40	M21-500-595-GN	BMP21-LAB	-	1	1
⊙	B-595	<b>F</b>	12.70	-	6.40	M21-500-595-OR	BMP21-LAB	-	1	1
⊙	B-595	<b>F</b>	12.70	-	6.40	M21-500-595-RD	BMP21-LAB	-	1	1
⊙	B-595	<b>F</b>	12.70	-	6.40	M21-500-595-WT	BMP21-LAB	-	1	1
⊙	B-430	<b>F A H</b>	12.70	-	6.40	M21-500-430-WT-CL	BMP21-LAB	-	1	1
⊙	B-595	<b>F</b>	12.70	-	6.40	M21-500-595-YL	BMP21-LAB	-	1	1
⊙	B-595	<b>F</b>	12.70	-	7.62	MC-500-595-BK-WT	BMP51, BMP53	-	1	1
⊙	B-595	<b>F</b>	12.70	-	7.62	MC-500-595-BL-WT	BMP51, BMP53	-	1	1
⊙	B-595	<b>F</b>	12.70	-	7.62	MC-500-595-GN-WT	BMP51, BMP53	-	1	1
⊙	B-595	<b>F</b>	12.70	-	7.62	MC-500-595-OR-BK	BMP51, BMP53	-	1	1
⊙	B-595	<b>F</b>	12.70	-	7.62	MC-500-595-RD-WT	BMP51, BMP53	-	1	1
⊙	B-595	<b>F</b>	12.70	-	7.62	MC-500-595-WT-BK	BMP51, BMP53	-	1	1
⊙	B-595	<b>F</b>	12.70	-	7.62	MC-500-595-WT-RD	BMP51, BMP53	-	1	1
⊙	B-595	<b>F</b>	12.70	-	7.62	MC-500-595-YL-BK	BMP51, BMP53	-	1	1
⊙	B-499	<b>F N A</b>	12.70	-	9.10	M71C-500-499	BMP71	M71-R4300	1	1
⊙	B-430	<b>F A H</b>	12.70	-	15.24	M71C-500-430	BMP71	M71-R6000HF	1	1
⊙	B-595	<b>F</b>	12.70	-	15.24	M71C-500-595-BK	BMP71	M71-R6000HF	1	1
⊙	B-595	<b>F</b>	12.70	-	15.24	M71C-500-595-BL	BMP71	M71-R6000HF	1	1
⊙	B-595	<b>F</b>	12.70	-	15.24	M71C-500-595-CL	BMP71	M71-R6000HF	1	1

>>



## Diagram

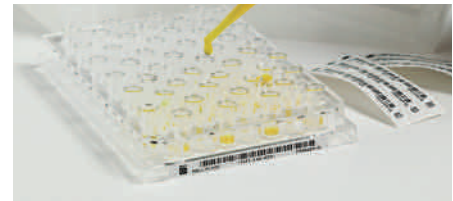
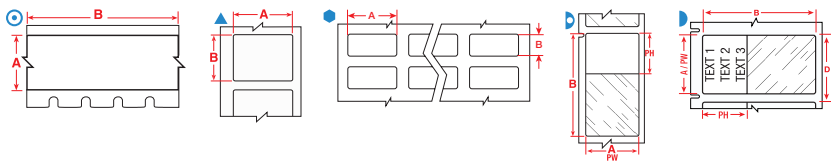
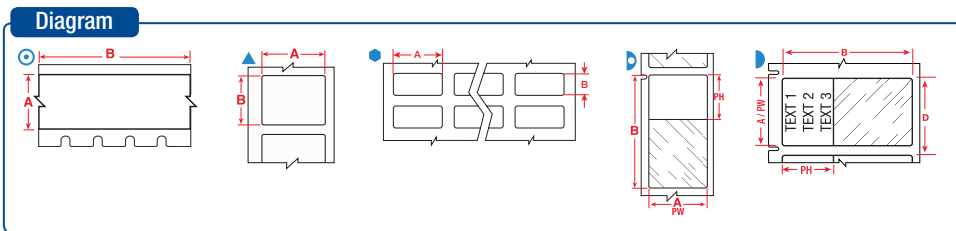
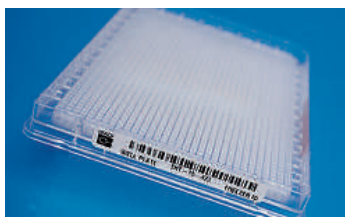

Diagram	Material	Special Properties	Label Width A (mm)	Label Height B (mm)	Label Length B (m)	Order Reference	Printer Compatibility	Printer Ribbon Series	Labels/ Package	Labels per Row
○	B-595	F	12.70	-	15.24	M71C-500-595-GN	BMP71	M71-R6000HF	1	1
○	B-595	F	12.70	-	15.24	M71C-500-595-OR	BMP71	M71-R6000HF	1	1
○	B-595	F	12.70	-	15.24	M71C-500-595-RD	BMP71	M71-R6000HF	1	1
○	B-595	F	12.70	-	15.24	M71C-500-595-WT	BMP71	M71-R6000HF	1	1
○	B-595	F	12.70	-	15.24	M71C-500-595-YL	BMP71	M71-R6000HF	1	1
○	B-595	F	12.70	-	30.40	B30C-500-595-BK	BBP33	B30-R10000-WT	1	1
○	B-595	F	12.70	-	30.40	B30C-500-595-BL	BBP33	B30-R10000-WT	1	1
○	B-595	F	12.70	-	30.40	B30C-500-595-CL	BBP33	B30-R10000	1	1
○	B-595	F	12.70	-	30.40	B30C-500-595-GN	BBP33	B30-R10000-WT	1	1
○	B-595	F	12.70	-	30.40	B30C-500-595-OR	BBP33	B30-R10000	1	1
○	B-595	F	12.70	-	30.40	B30C-500-595-RD	BBP33	B30-R10000-WT	1	1
○	B-595	F	12.70	-	30.40	B30C-500-595-WT	BBP33	B30-R10000	1	1
○	B-595	F	12.70	-	30.40	B30C-500-595-YL	BBP33	B30-R10000	1	1
▲	B-423	F AH	12.70	12.70	-	BM71-7-423	BMP71	M71-R6000HF	5000	1
▲	B-423	F AH	12.70	12.70	-	M71-7-423	BMP71	M71-R6000HF	500	1
○	B-499	F NA	19.05	-	4.88	M21-750-499	BMP21-LAB	-	1	1
○	B-499	F NA	19.05	-	4.88	MC-750-499	BMP51, BMP53	-	1	1
○	B-595	F	19.05	-	6.10	MC-750-595-CL-BK	BMP51, BMP53	-	1	1
○	B-595	F	19.05	-	6.10	MC-750-595-CL-WT	BMP51, BMP53	-	1	1
○	B-423	F AH	19.05	-	6.40	M21-750-423	BMP21-LAB	-	1	1
○	B-430	F AH	19.05	-	6.40	M21-750-430	BMP21-LAB	-	1	1
○	B-488	F A	19.05	-	6.40	M21-750-488	BMP21-LAB	-	1	1
○	B-7425	F NAH	19.05	-	6.40	M21-750-7425	BMP21-LAB	-	1	1
○	B-595	F	19.05	-	6.40	M21-750-595-BK	BMP21-LAB	-	1	1
○	B-595	F	19.05	-	6.40	M21-750-595-BL	BMP21-LAB	-	1	1
○	B-595	F	19.05	-	6.40	M21-750-595-GN	BMP21-LAB	-	1	1
○	B-595	F	19.05	-	6.40	M21-750-595-OR	BMP21-LAB	-	1	1
○	B-595	F	19.05	-	6.40	M21-750-595-RD	BMP21-LAB	-	1	1
○	B-595	F	19.05	-	6.40	M21-750-595-WT	BMP21-LAB	-	1	1
○	B-430	F AH	19.05	-	6.40	M21-750-430-WT-CL	BMP21-LAB	-	1	1
○	B-595	F	19.05	-	6.40	M21-750-595-YL	BMP21-LAB	-	1	1
○	B-595	F	19.05	-	7.62	MC-750-595-BK-WT	BMP51, BMP53	-	1	1
○	B-595	F	19.05	-	7.62	MC-750-595-BL-WT	BMP51, BMP53	-	1	1
○	B-595	F	19.05	-	7.62	MC-750-595-GN-WT	BMP51, BMP53	-	1	1
○	B-595	F	19.05	-	7.62	MC-750-595-OR-BK	BMP51, BMP53	-	1	1
○	B-595	F	19.05	-	7.62	MC-750-595-RD-WT	BMP51, BMP53	-	1	1
○	B-595	F	19.05	-	7.62	MC-750-595-WT-BK	BMP51, BMP53	-	1	1
○	B-595	F	19.05	-	7.62	MC-750-595-WT-RD	BMP51, BMP53	-	1	1
○	B-595	F	19.05	-	7.62	MC-750-595-YL-BK	BMP51, BMP53	-	1	1
●	B-8423	F A	19.05	6.35	-	BPT-1-8423-2.5	BBP12, BP-PR+	R6000	2500	5
▷	B-427	F N S	19.05	38.10	-	BM71-30-427	BMP71	M71-R4300	2500	1
▷	B-427	F N S	19.05	38.10	-	M-90-427	BMP51, BMP53	-	180	1
▷	B-427	F N S	19.05	38.10	-	M71-30-427	BMP71	M71-R4300	250	1
●	B-498	F R	20.32	36.50	-	B33-95-498	BBP33	B30-R6200	2300	3
●	B-498	F R	20.32	36.50	-	THT-95-498-5	BBP12, BP-PR+, IP	R4300, R7950	5000	3
▲	B-499	F NA	22.86	12.70	-	M71-84-499	BMP71	M71-R4300	500	1
●	B-488	F A	22.86	19.05	-	B33-616-488	BBP33	B30-R4300	3000	3
●	B-488	F A	22.86	22.86	-	B33-617-488	BBP33	B30-R4300	3000	3
○	B-499	F NA	25.40	-	4.88	MC-1000-499	BMP51, BMP53	-	1	1
○	B-595	F	25.40	-	6.10	MC1-1000-595-CL-BK	BMP51, BMP53	-	1	1
○	B-595	F	25.40	-	6.10	MC1-1000-595-CL-WT	BMP51, BMP53	-	1	1
○	B-595	F	25.40	-	7.62	MC1-1000-595-BK-WT	BMP51, BMP53	-	1	1
○	B-595	F	25.40	-	7.62	MC1-1000-595-BL-WT	BMP51, BMP53	-	1	1
○	B-595	F	25.40	-	7.62	MC1-1000-595-GN-WT	BMP51, BMP53	-	1	1
○	B-595	F	25.40	-	7.62	MC1-1000-595-OR-BK	BMP51, BMP53	-	1	1
○	B-595	F	25.40	-	7.62	MC1-1000-595-RD-WT	BMP51, BMP53	-	1	1
○	B-595	F	25.40	-	7.62	MC1-1000-595-WT-BK	BMP51, BMP53	-	1	1
○	B-595	F	25.40	-	7.62	MC1-1000-595-WT-RD	BMP51, BMP53	-	1	1
○	B-595	F	25.40	-	7.62	MC1-1000-595-YL-BK	BMP51, BMP53	-	1	1
○	B-499	F NA	25.40	-	9.10	M71C-1000-499	BMP71	M71-R4300	1	1
○	B-430	F AH	25.40	-	15.24	M71C-1000-430	BMP71	M71-R6000HF	1	1
○	B-595	F	25.40	-	15.24	M71C-1000-595-BK	BMP71	M71-R6000HF	1	1

>>

# Well Plate Labels



Labels are shown in order of label width.

The background colours in the Order Reference column represent the material colour.

See page 38 for Brady's range of label printers.

Diagram	Material	Special Properties	Label Width A (mm)	Label Height B (mm)	Label Length B (m)	Order Reference	Printer Compatibility	Printer Ribbon Series	Labels/Package	Labels per Row
⊙	B-595	F	25.40	-	15.24	M71C-1000-595-BL	BMP71	M71-R4400-WT	1	1
⊙	B-595	F	25.40	-	15.24	M71C-1000-595-CL	BMP71	M71-R6000HF	1	1
⊙	B-595	F	25.40	-	15.24	M71C-1000-595-GN	BMP71	M71-R4400-WT	1	1
⊙	B-595	F	25.40	-	15.24	M71C-1000-595-OR	BMP71	M71-R6000HF	1	1
⊙	B-595	F	25.40	-	15.24	M71C-1000-595-RD	BMP71	M71-R4400-WT	1	1
⊙	B-595	F	25.40	-	15.24	M71C-1000-595-WT	BMP71	M71-R6000HF	1	1
⊙	B-595	F	25.40	-	15.24	M71C-1000-595-YL	BMP71	M71-R6000HF	1	1
▲	B-423	F AH	25.40	4.75	-	M71-14-423	BMP71	M71-R6000HF	750	1
●	B-423	F AH	25.40	4.75	-	THT-41-423-10	BBP12, BP-PR+, IP	R6000HF	10000	3
●	B-423	F AH	25.40	6.35	-	THT-51-423-10	BBP12, BP-PR+, IP	R6000HF	10000	3
▲	B-423	F AH	25.40	6.99	-	M71-15-423	BMP71	M71-R6000HF	750	1
●	B-499	F NA	25.40	9.53	-	B33-152-499	BBP33	B30-R6000HF	1500	2
●	B-499	F NA	25.40	9.53	-	THT-152-499-3	BBP12, BP-PR+, IP	R4900	3000	2
●	B-499	F NA	25.40	9.53	-	THT-152-499-1.5-SC	BBP12, BP-PR+	R7950	1500	2
●	B-425	F	25.40	9.98	-	THT-30-425-10	BBP12, BP-PR+, IP	R6400	10000	3
▲	B-432	F A	25.40	12.70	-	M-17-432-CL-BK	BMP51, BMP53	-	280	1
▲	B-423	F AH	25.40	12.70	-	M71-17-423	BMP71	M71-R6000HF	500	1
▲	B-430	F AH	25.40	12.70	-	M71-17-430	BMP71	M71-R6000HF	500	1
▲	B-498	F R	25.40	12.70	-	M71-17-498	BMP71	M71-R6200	500	1
●	B-430	F AH	25.40	12.70	-	THT-39-430-10	BBP12, BP-PR+, IP	R6000HF	10000	3
●	B-498	F R	25.40	36.50	-	BPT-621-498	BBP12, BP-PR+	R7950	3000	3
●	B-498	F R	25.40	36.50	-	THT-89-498-5	BBP12, BP-PR+, IP	R4300, R7950	5000	3
▷	B-427	F N S	25.40	38.10	-	BM71-31-427	BMP71	M71-R4300	2500	1
▷	B-427	F N S	25.40	38.10	-	M-91-427	BMP51, BMP53	-	180	1
▷	B-427	F N S	25.40	38.10	-	M71-31-427	BMP71	M71-R4300	250	1
▷	B-461	F NAHS L	25.40	38.10	-	M71-31-461	BMP71	M71-R6200	250	1
▲	B-423	F AH	25.40	50.80	-	BM71-20-423	BMP71	M71-R6000HF	1000	1
▲	B-423	F AH	25.40	50.80	-	M71-20-423	BMP71	M71-R6000HF	100	1
▲	B-423	F AH	25.40	76.20	-	M71-22-423	BMP71	M71-R6000HF	100	1
●	B-423	F AH	27.94	9.65	-	THT-31-423-10	BBP12, BP-PR+, IP	R6000HF	10000	2
▲	B-498	F R	38.10	12.70	-	BM71-29-498	BMP71	M71-R6200	5000	1
▲	B-498	F R	38.10	12.70	-	M71-29-498	BMP71	M71-R6200	500	1
▲	B-499	F NA	38.10	12.70	-	M71-29-499	BMP71	M71-R4300	500	1
●	B-423	F AH	38.10	12.70	-	THT-37-423-10	BBP12, BP-PR+, IP	R6000HF	10000	2
▲	B-499	F NA	38.10	19.05	-	B33-136-499	BBP33	B30-R6000HF	1500	1
●	B-8423	F A	38.10	19.05	-	BPT-6-8423-2.5	BBP12, BP-PR+	R6000HF	2500	2
▲	B-499	F NA	38.10	19.05	-	M71-30-499	BMP71	M71-R4300	250	1
▲	B-427	F N S	38.10	19.05	-	M71-30-427-AW**	BMP71	M71-R4300	250	1
▲	B-499	F NA	38.10	19.05	-	THT-136-499-3	BBP12, BP-PR+, IP	R4900	3000	1
▲	B-499	F NA	38.10	19.05	-	THT-136-499-1.5-SC	BBP12, BP-PR+	R7950	1500	1
▲	B-423	F AH	38.10	25.40	-	M71-31-423	BMP71	M71-R6000HF	250	1
▲	B-498	F R	38.10	25.40	-	M71-31-498	BMP71	M71-R6200	250	1
▲	B-499	F NA	38.10	25.40	-	M71-31-499	BMP71	M71-R4300	250	1
⊙	B-499	F NA	48.26	-	9.10	M71C-1900-499	BMP71	M71-R4300	1	1
⊙	B-430	F AH	48.26	-	15.24	M71C-1900-430	BMP71	M71-R6000HF	1	1
▲	B-488	F A	48.26	6.35	-	B33-635-488	BBP33	B30-R4300	2000	1
▲	B-488	F A	48.26	6.35	-	BPT-635-488	BBP12, BP-PR+	R7950	2000	1
▲	B-488	F A	48.26	6.35	-	M71-81-488	BMP71	M71-R4300	750	1
▲	B-499	F NA	48.26	6.35	-	M71-81-499	BMP71	M71-R4300	750	1
▲	B-499	F NA	48.26	25.40	-	M71-78-499	BMP71	M71-R4300	250	1
▲	B-499	F NA	50.80	6.35	-	B33-151-499	BBP33	B30-R6000HF	1500	1
▲	B-499	F NA	50.80	6.35	-	THT-151-499-3	BBP12, BP-PR+, IP	R4900	3000	1
▲	B-499	F NA	50.80	6.35	-	THT-151-499-1.5-SC	BBP12, BP-PR+	R7950	1500	1
▲	B-423	F AH	50.80	6.35	-	THT-15-423-2.5	BBP12, BP-PR+, IP	R6000HF	2500	1
▲	B-423	F AH	63.50	5.08	-	THT-142-423-2.5	BBP12, BP-PR+, IP	R6000HF	2500	1
▲	B-430	F AH	76.20	25.40	-	THT-18-430-3	BBP12, BP-PR+, IP	R6000HF	3000	1
▲	B-430	F AH	76.20	50.80	-	THT-19-430-1	BBP12, BP-PR+, IP	R6000HF	1000	1

\*\*AW = All White / no transparent area.

F Freezer environment N Liquid nitrogen environment A Autoclave environment H Hot water bath (100°C) S Self-laminating label L Low-profile (extremely thin) label R Removable

## BOTTLES / FLASKS & DISHES

Brady's labels for bottles, flasks and dishes are easy to handle and flexible. This enables the labels to be placed on curved containers and remain attached and legible, even after being subjected to freezing, liquid nitrogen and heat.

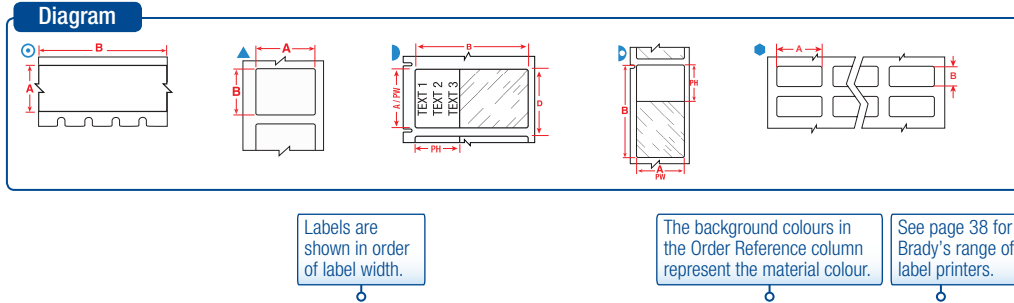

Diagram	Material	Special Properties	Label Width A (mm)	Label Height B (mm)	Label Length B (m)	Printable Area Width PW (mm)	Printable Area Height PH (mm)	Order Reference	Printer Compatibility	Printer Ribbon Series	Labels/Package	Labels per Row
⊙	B-423	<b>F A H</b>	6.35	—	6.40	—	—	M21-250-423	BMP21-LAB	—	1	1
⊙	B-430	<b>F A H</b>	6.35	—	6.40	—	—	M21-250-430	BMP21-LAB	—	1	1
⊙	B-430	<b>F A H</b>	6.35	—	6.40	—	—	M21-250-430-WT-CL	BMP21-LAB	—	1	1
⊙	B-499	<b>F N A</b>	9.53	—	4.88	—	—	M21-375-499	BMP21-LAB	—	1	1
⊙	B-499	<b>F N A</b>	9.53	—	4.88	—	—	MC-375-499	BMP51, BMP53	—	1	1
⊙	B-430	<b>F A H</b>	9.53	—	6.40	—	—	M21-375-430	BMP21-LAB	—	1	1
⊙	B-430	<b>F A H</b>	9.53	—	6.40	—	—	M21-375-430-WT-CL	BMP21-LAB	—	1	1
⊙	B-430	<b>F A H</b>	9.53	—	15.24	—	—	M71C-375-430	BMP71	M71-R6000HF	1	1
▲	B-499	<b>F N A</b>	9.53	20.96	—	—	—	M-130-499	BMP51, BMP53	—	220	1
⊙	B-499	<b>F N A</b>	12.70	—	4.88	—	—	M21-500-499	BMP21-LAB	—	1	1
⊙	B-499	<b>F N A</b>	12.70	—	4.88	—	—	MC-500-499	BMP51, BMP53	—	1	1
⊙	B-430	<b>F A H</b>	12.70	—	6.40	—	—	M21-500-430	BMP21-LAB	—	1	1
⊙	B-430	<b>F A H</b>	12.70	—	6.40	—	—	M21-500-430-WT-CL	BMP21-LAB	—	1	1
⊙	B-499	<b>F N A</b>	12.70	—	9.10	—	—	M71C-500-499	BMP71	M71-R4300	1	1
⊙	B-430	<b>F A H</b>	12.70	—	15.24	—	—	M71C-500-430	BMP71	M71-R6000HF	1	1
▲	B-423	<b>F A H</b>	12.70	12.70	—	—	—	BM71-7-423	BMP71	M71-R6000HF	5000	1
▲	B-423	<b>F A H</b>	12.70	12.70	—	—	—	M71-7-423	BMP71	M71-R6000HF	500	1
●	B-499	<b>F N A</b>	12.70	19.05	—	—	—	B33-68-499	BBP33	B30-R6000HF	1500	4
●	B-499	<b>F N A</b>	12.70	19.05	—	—	—	THT-68-499-10	BBP12, BP-PR+, IP	R4900	10000	4
▲	B-498	<b>F</b>	12.70	25.40	—	—	—	M-131-498	BMP51, BMP53	—	180	1
▲	B-499	<b>F N A</b>	12.70	25.40	—	—	—	M-131-499	BMP51, BMP53	—	180	1
⊙	B-499	<b>F N A</b>	19.05	—	4.88	—	—	M21-750-499	BMP21-LAB	—	1	1
⊙	B-499	<b>F N A</b>	19.05	—	4.88	—	—	MC-750-499	BMP51, BMP53	—	1	1
⊙	B-430	<b>F A H</b>	19.05	—	6.40	—	—	M21-750-430	BMP21-LAB	—	1	1
⊙	B-430	<b>F A H</b>	19.05	—	6.40	—	—	M21-750-430-WT-CL	BMP21-LAB	—	1	1
▷	B-427	<b>F N S</b>	19.05	38.10	—	19.05	12.70	BM71-30-427	BMP71	M71-R4300	2500	1
▷	B-427	<b>F N S</b>	19.05	38.10	—	19.05	12.70	M-90-427	BMP51, BMP53	—	180	1
▷	B-427	<b>F N S</b>	19.05	38.10	—	19.05	12.70	M71-30-427	BMP71	M71-R4300	250	1
▲	B-427	<b>F N S</b>	20.00	20.00	—	20.00	20.00	<b>BPTLAB-35-427-YL</b>	BBP12, BP-PR+, IP	R7950	1000	1
▲	B-499	<b>F N A</b>	22.86	12.70	—	—	—	B33-125-499	BBP33	B30-R6000HF	1500	1
▲	B-499	<b>F N A</b>	22.86	12.70	—	—	—	THT-125-499-3	BBP12, BP-PR+, IP	R4900	3000	1
▲	B-499	<b>F N A</b>	22.86	12.70	—	—	—	THT-125-499-1.5-SC	BBP12, BP-PR+, IP	R7950	1500	1
●	B-488	<b>F A</b>	22.86	19.05	—	—	—	B33-616-488	BBP33	B30-R4300	3000	3
●	B-488	<b>F A</b>	22.86	19.05	—	—	—	THT-140-488-3	BBP12, BP-PR+, IP	R4300, R7950	3000	2
●	B-488	<b>F A</b>	22.86	19.05	—	—	—	THT-140-488-1.5-SC	BBP12, BP-PR+, IP	R7950	1500	2
●	B-488	<b>F A</b>	22.86	22.86	—	—	—	B33-617-488	BBP33	B30-R4300	3000	3
▲	B-488	<b>F A</b>	22.86	22.86	—	—	—	THT-164-488-1-SC	BBP12, BP-PR+, IP	R7950	1000	1
●	B-488	<b>F A</b>	22.86	22.86	—	—	—	THT-141-488-3	BBP12, BP-PR+, IP	R4300, R7950	3000	2
⊙	B-499	<b>F N A</b>	25.40	—	4.88	—	—	MC-1000-499	BMP51, BMP53	—	1	1
⊙	B-499	<b>F N A</b>	25.40	—	9.10	—	—	M71C-1000-499	BMP71	M71-R4300	1	1
⊙	B-430	<b>F A H</b>	25.40	—	15.24	—	—	M71C-1000-430	BMP71	M71-R6000HF	1	1
▲	B-423	<b>F A H</b>	25.40	4.75	—	—	—	M71-14-423	BMP71	M71-R6000HF	750	1
●	B-423	<b>F A H</b>	25.40	4.75	—	—	—	THT-41-423-10	BBP12, BP-PR+, IP	R6000	10000	3
●	B-423	<b>F A H</b>	25.40	6.35	—	—	—	THT-51-423-10	BBP12, BP-PR+, IP	R6000	10000	3
▲	B-423	<b>F A H</b>	25.40	6.99	—	—	—	M71-15-423	BMP71	M71-R6000HF	750	1
●	B-499	<b>F N A</b>	25.40	9.53	—	—	—	B33-152-499	BBP33	B30-R6000HF	1500	2
●	B-499	<b>F N A</b>	25.40	9.53	—	—	—	THT-152-499-3	BBP12, BP-PR+, IP	R4900	3000	2
●	B-499	<b>F N A</b>	25.40	9.53	—	—	—	THT-152-499-1.5-SC	BBP12, BP-PR+, IP	R7950	1500	2
●	B-425	<b>F</b>	25.40	9.98	—	—	—	THT-30-425-10	BBP12, BP-PR+, IP	R6400	10000	3
●	B-423	<b>F A H</b>	25.40	12.70	—	—	—	B33-5-423	BBP33	B30-R6000HF	5000	3
▲	B-423	<b>F A H</b>	25.40	12.70	—	—	—	M71-17-423	BMP71	M71-R6000HF	500	1
▲	B-498	<b>F</b>	25.40	12.70	—	—	—	M71-17-498	BMP71	M71-R6200	500	1

>>

**F** Freezer environment **N** Liquid nitrogen environment **A** Autoclave environment **H** Hot water bath (100°C) **S** Self-laminating label **L** Low-profile (extremely thin) label **R** Removable

# Bottles / Flasks & Dishes

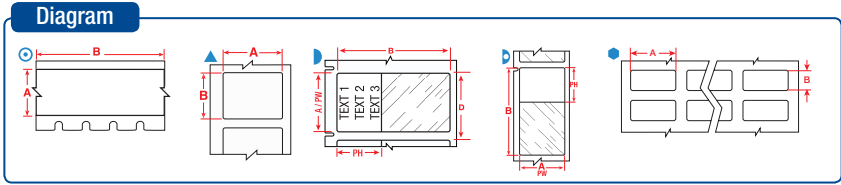

Diagram	Material	Special Properties	Label Width A (mm)	Label Height B (mm)	Label Length B (m)	Printable Area Width PW (mm)	Printable Area Height PH (mm)	Order Reference	Printer Compatibility	Printer Ribbon Series	Labels/Package	Labels per Row
▲	B-498	F R	25.40	12.70	-	-	-	THT-59-498-10	BBP12, BP-PR+, IP	R4300, R7950	10000	1
▲	B-533	F A R	25.40	12.70	-	-	-	THT-59-533-10	BBP12, BP-PR+, IP	R6000HF	10000	1
▲	B-498	F R	25.40	12.70	-	-	-	THT-59-498-2.5-SC	BBP12, BP-PR+, IP	R7950	2500	1
●	B-430	F A H	25.40	12.70	-	-	-	THT-39-430-10	BBP12, BP-PR+, IP	R6000HF	10000	3
●	B-488	F A	25.40	12.70	-	-	-	THT-5-488-10	BBP12, BP-PR+, IP	R4300, R7950	10000	3
●	B-492	F N H L	25.40	19.05	-	-	-	THT-88-492-5	BBP12, BP-PR+, IP	R6400	5000	2
▲	B-492	F N H L	25.40	25.40	-	-	-	M71-19-492	BMP71	M71-R6400	250	1
▲	B-499	F N A	25.40	25.40	-	-	-	M71-19-499	BMP71	M71-R4300	250	1
▲	B-498	F R	25.40	31.75	-	-	-	M-103-498	BMP51, BMP53	-	160	1
▷	B-427	F N S	25.40	38.10	-	25.40	12.70	BM71-31-427	BMP71	M71-R4300	2500	1
▷	B-427	F N S	25.40	38.10	-	25.40	12.70	M-91-427	BMP51, BMP53	-	180	1
▷	B-427	F N S	25.40	38.10	-	25.40	12.70	M71-31-427	BMP71	M71-R4300	250	1
▲	B-498	F R	25.40	48.26	-	-	-	M-128-498	BMP51, BMP53	-	100	1
▲	B-499	F N A	25.40	50.80	-	-	-	B33-137-499	BBP33	B30-R6000HF	1100	1
▲	B-423	F A H	25.40	50.80	-	-	-	BM71-20-423	BMP71	M71-R6000HF	1000	1
▲	B-423	F A H	25.40	50.80	-	-	-	M71-20-423	BMP71	M71-R6000HF	100	1
▲	B-423	F A H	25.40	76.20	-	-	-	M71-22-423	BMP71	M71-R6000HF	100	1
▲	B-498	F R	26.67	6.35	-	-	-	THT-199-498-3	BBP12, BP-PR+, IP	R4300, R7950	3000	1
▲	B-498	F R	26.67	6.35	-	-	-	THT-199-498-3-SC	BBP12, BP-PR+, IP	R7950	3000	1
▲	B-423	F A H	31.75	69.85	-	-	-	M71-26-423	BMP71	M71-R6000HF	100	1
▲	B-499	F N A	38.10	12.70	-	-	-	M71-29-499	BMP71	M71-R4300	500	1
▲	B-499	F N A	38.10	19.05	-	-	-	B33-136-499	BBP33	B30-R6000HF	1500	1
●	B-8423	F A	38.10	19.05	-	-	-	B33-6-8423	BBP33	B30-R6000HF	2500	2
▲	B-499	F N A	38.10	19.05	-	-	-	M71-30-499	BMP71	M71-R4300	250	1
▲	B-499	F N A	38.10	19.05	-	-	-	THT-136-499-3	BBP12, BP-PR+, IP	R4900	3000	1
▲	B-499	F N A	38.10	19.05	-	-	-	THT-136-499-1.5-SC	BBP12, BP-PR+, IP	R7950	1500	1
▲	B-427	F N S	38.10	19.05	-	38.10	19.05	M71-30-427-AW**	BMP71	M71-R4300	250	1
▲	B-423	F A H	38.10	25.40	-	-	-	M71-31-423	BMP71	M71-R6000HF	250	1
▲	B-499	F N A	38.10	25.40	-	-	-	M71-31-499	BMP71	M71-R4300	250	1
▲	B-499	F N A	38.10	31.75	-	-	-	M-132-499	BMP51, BMP53	-	160	1
○	B-499	F N A	48.26	-	9.10	-	-	M71C-1900-499	BMP71	M71-R4300	1	1
○	B-430	F A H	48.26	-	15.24	-	-	M71C-1900-430	BMP71	M71-R6000HF	1	1
▲	B-488	F A	48.26	6.35	-	-	-	B33-635-488	BBP33	B30-R4300	2000	1
▲	B-499	F N A	48.26	25.40	-	-	-	M71-78-499	BMP71	M71-R4300	250	1
▲	B-499	F N A	50.80	6.35	-	-	-	B33-151-499	BBP33	B30-R6000HF	1500	1
▲	B-499	F N A	50.80	6.35	-	-	-	THT-151-499-3	BBP12, BP-PR+, IP	R4900	3000	1
▲	B-499	F N A	50.80	6.35	-	-	-	THT-151-499-1.5-SC	BBP12, BP-PR+, IP	R7950	1500	1
▲	B-488	F A	50.80	6.35	-	-	-	THT-15-488-2.5	BBP12, BP-PR+, IP	R7950	2500	1
▲	B-423	F A H	50.80	25.40	-	-	-	B33-17-423	BBP33	B30-R6000HF	1500	1
▲	B-425	F	50.80	25.40	-	-	-	B33-17-425	BBP33	B30-R4300	1500	1
▲	B-430	F A H	50.80	25.40	-	-	-	B33-17-430	BBP33	B30-R6000HF	1500	1
▲	B-432	F A	50.80	25.40	-	-	-	B33-17-432	BBP33	B30-R6000HF	5000	1
▲	B-8423	F A	50.80	25.40	-	-	-	BPT-17-8423-1	BBP12, BP-PR+, IP	R6000HF	1000	1
▲	B-423	F A H	50.80	25.40	-	-	-	THT-17-423-3	BBP12, BP-PR+, IP	R6000HF	3000	1
▲	B-425	F	50.80	25.40	-	-	-	THT-17-425-3	BBP12, BP-PR+, IP	R6400	3000	1
▲	B-430	F A H	50.80	25.40	-	-	-	THT-17-430-3	BBP12, BP-PR+, IP	R6000HF	3000	1
▲	B-498	F R	50.80	25.40	-	-	-	THT-17-498-3	BBP12, BP-PR+, IP	R4300, R7950	3000	1
▲	B-533	F A R	50.80	25.40	-	-	-	THT-17-533-3	BBP12, BP-PR+, IP	R6000HF	3000	1
▲	B-498	F R	50.80	25.40	-	-	-	THT-17-498-1.5-SC	BBP12, BP-PR+, IP	R7950	1500	1
▲	B-8423	F A	69.85	31.75	-	-	-	BPT-7-8423-1	BBP12, BP-PR+, IP	R6000HF	1000	1
▲	B-423	F A H	76.20	25.40	-	-	-	B33-18-423	BBP33	B30-R6000HF	1500	1
▲	B-430	F A H	76.20	25.40	-	-	-	B33-18-430	BBP33	B30-R6000HF	1500	1
▲	B-432	F A	76.20	25.40	-	-	-	B33-18-432	BBP33	B30-R6000HF	1500	1
▲	B-423	F A H	76.20	25.40	-	-	-	THT-18-423-3	BBP12, BP-PR+, IP	R6000HF	3000	1
▲	B-432	F A	76.20	50.80	-	-	-	B33-19-432	BBP33	B30-R6000HF	500	1
▲	B-432	F A	76.20	50.80	-	-	-	THT-19-432-1	BBP12, BP-PR+, IP	R6000HF	1000	1
▲	B-490	F N H L	95.25	38.10	-	-	-	THT-158-490-3	BBP12, BP-PR+, IP	R4300, R7950	3000	1
▲	B-490	F N H L	95.25	38.10	-	-	-	THT-158-490-1.5-SC	BBP12, BP-PR+, IP	R7950	1500	1

\*\*AW = All White / no transparent area.

**F** Freezer environment **N** Liquid nitrogen environment **A** Autoclave environment **H** Hot water bath (100°C) **S** Self-laminating label **L** Low-profile (extremely thin) label **R** Removable



- F** Freezer environment
- N** Liquid nitrogen environment
- A** Autoclave environment
- H** Hot water bath (100°C)
- S** Self-laminating label
- L** Low-profile (extremely thin) label
- R** Removable

## BOTTLE TAMPER SEAL LABELS

Brady's bottle seal identification provides tracking information with the added feature of security. These labelling materials are designed to fracture easily in order to show signs of sample tampering and to prevent one-piece label removal.

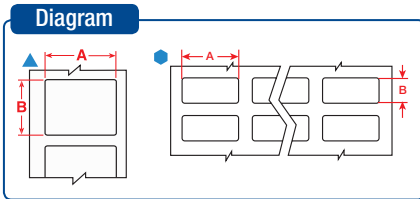

Labels are shown in order of label width.

The background colours in the Order Reference column represent the material colour.

See page 38 for Brady's range of label printers.

Diagram	Material	Special Properties	Label Width A (mm)	Label Height B (mm)	Order Reference	Printer Compatibility	Printer Ribbon Series	Labels/ Package	Labels per Row
▲	B-351	<b>F</b>	25.40	12.70	M-17-351	BMP51, BMP53	—	360	1
▲	B-351	<b>F</b>	25.40	12.70	M71-17-351	BMP71	M71-R6000HF	500	1
●	B-7351	<b>F</b>	25.40	12.70	THT-5-7351-10	BBP12, BP-PR+, IP	R6000	10000	3
▲	B-351	<b>F</b>	25.40	50.80	M-20-351	BMP51, BMP53	—	160	1
▲	B-351	<b>F</b>	25.40	50.80	M71-20-351	BMP71	M71-R6000HF	100	1
▲	B-351	<b>F</b>	38.10	25.40	M71-31-351	BMP71	M71-R6000HF	250	1
▲	B-7351	<b>F</b>	50.80	25.40	THT-17-7351-3	BBP12, BP-PR+, IP	R6000	3000	1
▲	B-351	<b>F</b>	76.20	48.26	M71-37-351	BMP71	M71-R6000HF	100	1



To find out how Brady helps some of the world's leading research laboratories develop more efficient labelling protocols visit [www.bradyeurope.com/lab](http://www.bradyeurope.com/lab)



### Part number explanation

Most Brady references for printable labels follow the same three-part format: The first code indicates the technology, the second part is a number indicating the label size (where applicable) and the third part indicates the Brady material (where applicable).

## M71-73-461

BMP71  
Technology

Label size  
code

Material  
(B-number)



## GENERAL LAB ID

Just like a durable sample label lets you know which sample you are holding, a cabinet or drawer label can inform you of the cabinet's content. With proper identification, time spent looking for the right sample or tool can be invested in what really matters. Brady offers a range of materials suitable for identifying drawers, cabinets, shelves, storage units and laboratory equipment.

- F** Freezer environment
- N** Liquid nitrogen environment
- A** Autoclave environment
- H** Hot water bath (100°C)
- S** Self-laminating label
- L** Low-profile (extremely thin) label
- R** Removable

Diagram

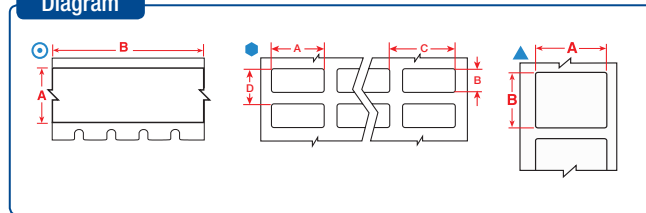

Labels are shown in order of label width.

The background colours in the Order Reference column represent the material colour

See page 38 for Brady's range of label printers.

Diagram	Material	Special Properties	Label Width A (mm)	Label Height B (mm)	Label Length B (m)	Order Reference	Printer Compatibility	Printer Ribbon Series	Labels/Package	Labels per Row
⊙	B-423	F AH	6.35	-	6.40	M21-250-423	BMP21-LAB	-	1	1
⊙	B-430	F AH	6.35	-	6.40	M21-250-430	BMP21-LAB	-	1	1
⊙	B-595	F	6.35	-	6.40	M21-250-595-WT	BMP21-LAB	-	1	1
⊙	B-430	F AH	6.35	-	6.40	M21-250-430-WT-CL	BMP21-LAB	-	1	1
⊙	B-595	F	6.35	-	6.40	M21-250-595-YL	BMP21-LAB	-	1	1
⊙	B-499	F NA	9.53	-	4.88	M21-375-499	BMP21-LAB	-	1	1
⊙	B-499	F NA	9.53	-	4.88	MC-375-499	BMP51, BMP53	-	1	1
⊙	B-423	F AH	9.53	-	6.40	M21-375-423	BMP21-LAB	-	1	1
⊙	B-430	F AH	9.53	-	6.40	M21-375-430	BMP21-LAB	-	1	1
⊙	B-488	F A	9.53	-	6.40	M21-375-488	BMP21-LAB	-	1	1
⊙	B-595	F	9.53	-	6.40	M21-375-595-BK	BMP21-LAB	-	1	1
⊙	B-595	F	9.53	-	6.40	M21-375-595-BL	BMP21-LAB	-	1	1
⊙	B-595	F	9.53	-	6.40	M21-375-595-GN	BMP21-LAB	-	1	1
⊙	B-595	F	9.53	-	6.40	M21-375-595-OR	BMP21-LAB	-	1	1
⊙	B-595	F	9.53	-	6.40	M21-375-595-RD	BMP21-LAB	-	1	1
⊙	B-595	F	9.53	-	6.40	M21-375-595-WT	BMP21-LAB	-	1	1
⊙	B-430	F AH	9.53	-	6.40	M21-375-430-WT-CL	BMP21-LAB	-	1	1
⊙	B-595	F	9.53	-	6.40	M21-375-595-YL	BMP21-LAB	-	1	1
⊙	B-595	F	9.53	-	7.62	MC-375-595-WT-BK	BMP51, BMP53	-	1	1
⊙	B-595	F	9.53	-	7.62	MC-375-595-YL-BK	BMP51, BMP53	-	1	1
⊙	B-430	F AH	9.53	-	15.24	M71C-375-430	BMP71	M71-R6000HF	1	1
▲	B-499	F NA	9.53	20.96	-	M-130-499	BMP51, BMP53	-	220	1
⊙	B-499	F NA	12.70	-	4.88	M21-500-499	BMP21-LAB	-	1	1
⊙	B-499	F NA	12.70	-	4.88	MC-500-499	BMP51, BMP53	-	1	1
⊙	B-595	F	12.70	-	6.10	MC-500-595-CL-BK	BMP51, BMP53	-	1	1
⊙	B-595	F	12.70	-	6.10	MC-500-595-CL-WT	BMP51, BMP53	-	1	1
⊙	B-423	F AH	12.70	-	6.40	M21-500-423	BMP21-LAB	-	1	1
⊙	B-430	F AH	12.70	-	6.40	M21-500-430	BMP21-LAB	-	1	1
⊙	B-488	F A	12.70	-	6.40	M21-500-488	BMP21-LAB	-	1	1
⊙	B-595	F	12.70	-	6.40	M21-500-595-BK	BMP21-LAB	-	1	1
⊙	B-595	F	12.70	-	6.40	M21-500-595-BL	BMP21-LAB	-	1	1
⊙	B-595	F	12.70	-	6.40	M21-500-595-GN	BMP21-LAB	-	1	1
⊙	B-595	F	12.70	-	6.40	M21-500-595-OR	BMP21-LAB	-	1	1
⊙	B-595	F	12.70	-	6.40	M21-500-595-RD	BMP21-LAB	-	1	1
⊙	B-595	F	12.70	-	6.40	M21-500-595-WT	BMP21-LAB	-	1	1
⊙	B-430	F AH	12.70	-	6.40	M21-500-430-WT-CL	BMP21-LAB	-	1	1
⊙	B-595	F	12.70	-	6.40	M21-500-595-YL	BMP21-LAB	-	1	1
⊙	B-595	F	12.70	-	7.62	MC-500-595-BK-WT	BMP51, BMP53	-	1	1
⊙	B-595	F	12.70	-	7.62	MC-500-595-BL-WT	BMP51, BMP53	-	1	1
⊙	B-595	F	12.70	-	7.62	MC-500-595-GN-WT	BMP51, BMP53	-	1	1
⊙	B-595	F	12.70	-	7.62	MC-500-595-OR-BK	BMP51, BMP53	-	1	1
⊙	B-595	F	12.70	-	7.62	MC-500-595-RD-WT	BMP51, BMP53	-	1	1

>>

## Diagram

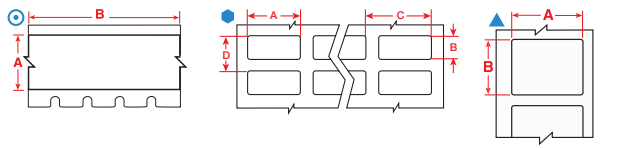
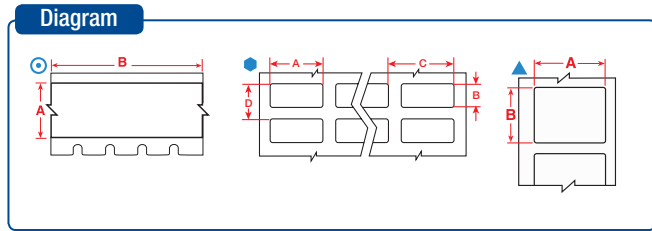

Diagram	Material	Special Properties	Label Width A (mm)	Label Height B (mm)	Label Length B (m)	Order Reference	Printer Compatibility	Printer Ribbon Series	Labels/Package	Labels per Row
⊙	B-595	F	12.70	-	7.62	MC-500-595-WT-BK	BMP51, BMP53	-	1	1
⊙	B-595	F	12.70	-	7.62	MC-500-595-WT-RD	BMP51, BMP53	-	1	1
⊙	B-595	F	12.70	-	7.62	MC-500-595-YL-BK	BMP51, BMP53	-	1	1
⊙	B-499	F N A	12.70	-	9.10	M71C-500-499	BMP71	M71-R4300	1	1
⊙	B-430	F A H	12.70	-	15.24	M71C-500-430	BMP71	M71-R6000HF	1	1
⊙	B-595	F	12.70	-	15.24	M71C-500-595-BK	BMP71	M71-R6000HF	1	1
⊙	B-595	F	12.70	-	15.24	M71C-500-595-BL	BMP71	M71-R6000HF	1	1
⊙	B-595	F	12.70	-	15.24	M71C-500-595-CL	BMP71	M71-R6000HF	1	1
⊙	B-595	F	12.70	-	15.24	M71C-500-595-GN	BMP71	M71-R6000HF	1	1
⊙	B-595	F	12.70	-	15.24	M71C-500-595-OR	BMP71	M71-R6000HF	1	1
⊙	B-595	F	12.70	-	15.24	M71C-500-595-RD	BMP71	M71-R6000HF	1	1
⊙	B-595	F	12.70	-	15.24	M71C-500-595-WT	BMP71	M71-R6000HF	1	1
⊙	B-595	F	12.70	-	15.24	M71C-500-595-YL	BMP71	M71-R6000HF	1	1
⊙	B-595	F	12.70	-	30.40	B30C-500-595-BK	BBP33	B30-R10000-WT	1	1
⊙	B-595	F	12.70	-	30.40	B30C-500-595-BL	BBP33	B30-R10000-WT	1	1
⊙	B-595	F	12.70	-	30.40	B30C-500-595-CL	BBP33	B30-R10000	1	1
⊙	B-595	F	12.70	-	30.40	B30C-500-595-GN	BBP33	B30-R10000-WT	1	1
⊙	B-595	F	12.70	-	30.40	B30C-500-595-OR	BBP33	B30-R10000	1	1
⊙	B-595	F	12.70	-	30.40	B30C-500-595-RD	BBP33	B30-R10000-WT	1	1
⊙	B-595	F	12.70	-	30.40	B30C-500-595-WT	BBP33	B30-R10000	1	1
⊙	B-595	F	12.70	-	30.40	B30C-500-595-YL	BBP33	B30-R10000	1	1
▲	B-498	F R	12.70	25.40	-	M-131-498	BMP51, BMP53	-	180	1
▲	B-499	F N A	12.70	25.40	-	M-131-499	BMP51, BMP53	-	180	1
▲	B-424	F	12.70	50.80	-	B33-53-424	BBP33	B30-R4300	2500	1
⊙	B-499	F N A	19.05	-	4.88	M21-750-499	BMP21-LAB	-	1	1
⊙	B-499	F N A	19.05	-	4.88	MC-750-499	BMP51, BMP53	-	1	1
⊙	B-595	F	19.05	-	6.10	MC-750-595-CL-BK	BMP51, BMP53	-	1	1
⊙	B-595	F	19.05	-	6.10	MC-750-595-CL-WT	BMP51, BMP53	-	1	1
⊙	B-423	F A H	19.05	-	6.40	M21-750-423	BMP21-LAB	-	1	1
⊙	B-430	F A H	19.05	-	6.40	M21-750-430	BMP21-LAB	-	1	1
⊙	B-488	F A	19.05	-	6.40	M21-750-488	BMP21-LAB	-	1	1
⊙	B-595	F	19.05	-	6.40	M21-750-595-BK	BMP21-LAB	-	1	1
⊙	B-595	F	19.05	-	6.40	M21-750-595-BL	BMP21-LAB	-	1	1
⊙	B-595	F	19.05	-	6.40	M21-750-595-GN	BMP21-LAB	-	1	1
⊙	B-595	F	19.05	-	6.40	M21-750-595-OR	BMP21-LAB	-	1	1
⊙	B-595	F	19.05	-	6.40	M21-750-595-RD	BMP21-LAB	-	1	1
⊙	B-595	F	19.05	-	6.40	M21-750-595-WT	BMP21-LAB	-	1	1
⊙	B-430	F A H	19.05	-	6.40	M21-750-430-WT-CL	BMP21-LAB	-	1	1
⊙	B-595	F	19.05	-	6.40	M21-750-595-YL	BMP21-LAB	-	1	1
⊙	B-595	F	19.05	-	7.62	MC-750-595-BK-WT	BMP51, BMP53	-	1	1
⊙	B-595	F	19.05	-	7.62	MC-750-595-BL-WT	BMP51, BMP53	-	1	1
⊙	B-595	F	19.05	-	7.62	MC-750-595-GN-WT	BMP51, BMP53	-	1	1
⊙	B-595	F	19.05	-	7.62	MC-750-595-OR-BK	BMP51, BMP53	-	1	1
⊙	B-595	F	19.05	-	7.62	MC-750-595-RD-WT	BMP51, BMP53	-	1	1
⊙	B-595	F	19.05	-	7.62	MC-750-595-WT-BK	BMP51, BMP53	-	1	1
⊙	B-595	F	19.05	-	7.62	MC-750-595-WT-RD	BMP51, BMP53	-	1	1
⊙	B-595	F	19.05	-	7.62	MC-750-595-YL-BK	BMP51, BMP53	-	1	1
⊙	B-499	F N A	25.40	-	4.88	MC-1000-499	BMP51, BMP53	-	1	1
⊙	B-595	F	25.40	-	6.10	MC1-1000-595-CL-BK	BMP51, BMP53	-	1	1
⊙	B-595	F	25.40	-	6.10	MC1-1000-595-CL-WT	BMP51, BMP53	-	1	1
⊙	B-595	F	25.40	-	7.62	MC1-1000-595-BK-WT	BMP51, BMP53	-	1	1
⊙	B-595	F	25.40	-	7.62	MC1-1000-595-BL-WT	BMP51, BMP53	-	1	1
⊙	B-595	F	25.40	-	7.62	MC1-1000-595-GN-WT	BMP51, BMP53	-	1	1
⊙	B-595	F	25.40	-	7.62	MC1-1000-595-OR-BK	BMP51, BMP53	-	1	1
⊙	B-595	F	25.40	-	7.62	MC1-1000-595-RD-WT	BMP51, BMP53	-	1	1
⊙	B-595	F	25.40	-	7.62	MC1-1000-595-WT-BK	BMP51, BMP53	-	1	1
⊙	B-595	F	25.40	-	7.62	MC1-1000-595-WT-RD	BMP51, BMP53	-	1	1
⊙	B-595	F	25.40	-	7.62	MC1-1000-595-YL-BK	BMP51, BMP53	-	1	1
⊙	B-499	F N A	25.40	-	9.10	M71C-1000-499	BMP71	M71-R4300	1	1
⊙	B-430	F A H	25.40	-	15.24	M71C-1000-430	BMP71	M71-R6000HF	1	1

>>

F Freezer environment N Liquid nitrogen environment A Autoclave environment H Hot water bath (100°C) S Self-laminating label L Low-profile (extremely thin) label R Removable

# General Lab ID



Labels are shown in order of label width.

The background colours in the Order Reference column represent the material colour.

See page 38 for Brady's range of label printers.

Diagram	Material	Special Properties	Label Width A (mm)	Label Height B (mm)	Label Length B (m)	Order Reference	Printer Compatibility	Printer Ribbon Series	Labels/Package	Labels per Row
⊙	B-595	F	25.40	-	15.24	M71C-1000-595-BK	BMP71	M71-R4400-WT	1	1
⊙	B-595	F	25.40	-	15.24	M71C-1000-595-BL	BMP71	M71-R4400-WT	1	1
⊙	B-595	F	25.40	-	15.24	M71C-1000-595-CL	BMP71	M71-R6000HF	1	1
⊙	B-595	F	25.40	-	15.24	M71C-1000-595-GN	BMP71	M71-R4400-WT	1	1
⊙	B-595	F	25.40	-	15.24	M71C-1000-595-OR	BMP71	M71-R6000HF	1	1
⊙	B-595	F	25.40	-	15.24	M71C-1000-595-RD	BMP71	M71-R4400-WT	1	1
⊙	B-595	F	25.40	-	15.24	M71C-1000-595-WT	BMP71	M71-R6000HF	1	1
⊙	B-595	F	25.40	-	15.24	M71C-1000-595-YL	BMP71	M71-R6000HF	1	1
●	B-423	F AH	25.40	12.70	-	B33-5-423	BBP33	B30-R6000HF	5000	3
▲	B-432	F A	25.40	12.70	-	M-17-432-CL-BK	BMP51, BMP53	-	280	1
▲	B-430	F AH	25.40	12.70	-	M71-17-430	BMP71	M71-R6000HF	500	1
▲	B-498	F R	25.40	12.70	-	M71-17-498	BMP71	M71-R6200	500	1
▲	B-498	F R	25.40	12.70	-	THT-59-498-2.5-SC	BBP12, BP-PR+	R7950	2500	1
●	B-488	F A	25.40	12.70	-	THT-5-488-10	BBP12, BP-PR+	R4300, R7950	10000	3
▲	B-492	F N H L	25.40	25.40	-	M71-19-492	BMP71	M71-R6400	250	1
▲	B-499	F N A	25.40	25.40	-	M71-19-499	BMP71	M71-R4300	250	1
▲	B-498	F R	25.40	31.75	-	M-103-498	BMP51, BMP53	-	160	1
▲	B-498	F R	25.40	48.26	-	M-128-498	BMP51, BMP53	-	100	1
▲	B-432	F A	25.40	48.26	-	M-78-432-CL-BK	BMP51, BMP53	-	100	1
▲	B-424	F	25.40	50.80	-	BM71-20-424	BMP71	M71-R4300	1000	1
▲	B-424	F	25.40	50.80	-	M71-20-424	BMP71	M71-R4300	100	1
▲	B-498	F R	26.67	6.35	-	THT-199-498-3	BBP12, BP-PR+	R4300, R7950	3000	1
▲	B-498	F R	26.67	6.35	-	THT-199-498-3-SC	BBP12, BP-PR+	R7950	3000	1
▲	B-423	F AH	31.75	69.85	-	M71-26-423	BMP71	M71-R6000HF	100	1
●	B-423	F AH	38.10	19.05	-	THT-6-423-10	BBP12, BP-PR+	R6000HF	10000	2
●	B-449	F A R	38.10	19.05	-	THT-6-449-3	BBP12, BP-PR+	R4300, R7950	3000	2
●	B-449	F A R	38.10	19.05	-	THT-6-449-1.5-SC	BBP12, BP-PR+	R7950	1500	2
▲	B-499	F N A	38.10	31.75	-	M-132-499	BMP51, BMP53	-	160	1
⊙	B-499	F N A	48.26	-	9.10	M71C-1900-499	BMP71	M71-R4300	1	1
⊙	B-430	F AH	48.26	-	15.24	M71C-1900-430	BMP71	M71-R6000HF	1	1
▲	B-423	F AH	50.80	12.70	-	THT-53-423-3	BBP12, BP-PR+	R6000HF	3000	1
▲	B-424	F	50.80	12.70	-	THT-53-424-3	BBP12, BP-PR+	R4300, R7950	3000	1
▲	B-423	F AH	50.80	25.40	-	B33-17-423	BBP33	B30-R6000HF	1500	1
▲	B-424	F	50.80	25.40	-	B33-17-424	BBP33	B30-R4300	1500	1
▲	B-8423	F A	50.80	25.40	-	BPT-17-8423-1	BBP12, BP-PR+	R6000HF	1000	1
▲	B-423	F AH	50.80	25.40	-	THT-17-423-3	BBP12, BP-PR+	R6000HF	3000	1
▲	B-424	F	50.80	25.40	-	THT-17-424-3	BBP12, BP-PR+	R4300, R7950	3000	1
▲	B-449	F A R	50.80	25.40	-	THT-17-449-3	BBP12, BP-PR+	R4300, R7950	3000	1
▲	B-498	F R	50.80	25.40	-	THT-17-498-3	BBP12, BP-PR+	R4300, R7950	3000	1
▲	B-449	F A R	50.80	25.40	-	THT-17-449-1.5-SC	BBP12, BP-PR+	R7950	1500	1
▲	B-498	F R	50.80	25.40	-	THT-17-498-1.5-SC	BBP12, BP-PR+	R7950	1500	1
▲	B-8423	F A	69.85	31.75	-	BPT-7-8423-1	BBP12, BP-PR+	R6000HF	1000	1
▲	B-423	F AH	76.20	25.40	-	B33-18-423	BBP33	B30-R6000HF	1500	1
▲	B-423	F AH	76.20	25.40	-	THT-18-423-3	BBP12, BP-PR+	R6000HF	3000	1
▲	B-430	F AH	76.20	25.40	-	THT-18-430-3	BBP12, BP-PR+	R6000HF	3000	1
▲	B-430	F AH	76.20	50.80	-	THT-19-430-1	BBP12, BP-PR+	R6000HF	1000	1

F Freezer environment N Liquid nitrogen environment A Autoclave environment H Hot water bath (100°C) S Self-laminating label L Low-profile (extremely thin) label R Removable



## Label Printers, Label Attachment System and Barcode Scanners

Brady printers enable professionals to print highly specialised identification labels on-site and on demand. Partnered with labelling software for laboratories, Brady printers support considerable time savings and flexibility in sample identification.

For enhanced security Brady offers a label attachment system that rivets an adhesive label to tissue cassettes before the tissue embedding process.

To complete your sample ID automation, Brady has a range of barcode scanners which combine the industry's best imaging technology with a graphic display and rugged keyboard for fast, user-friendly data and inventory management.

Choose Your Printer .....	38
BMP™21-LAB Label Printer .....	40
BMP™51 Label Maker .....	41
BMP™71 Portable Label Printer .....	42
BBP™12 Label Printer.....	43
BBP™33 Label Printer.....	44
Brady IP™ Series Printer .....	45
BradyPrinter PR Plus Thermal Transfer Printer.....	46
BSP™31 Label Attachment System.....	47
Label Creation Software.....	48
Scanners for Laboratories.....	49



# Choose Your Printer



**BMP™21-LAB Label Printer**

**BMP™51 Label Maker**

**BMP™71 Label Printer**

The BMP™21-LAB Portable Label Printer is an all-in-one labeller for research, academic and clinical labs. The BMP21-LAB printer can quickly and easily create legible labels for flat, curved or highly textured surfaces that stay stuck for years even when exposed to extreme temperatures and chemicals.

A powerful portable printer for on the job labelling in laboratories. With its extensive connectivity and networking options this easy to use system prints a large variety of high quality continuous and die-cut materials up to 38 mm wide.

The most versatile portable printer for on the job labelling in laboratories. With its optimal efficiency it helps to reduce material waste and saves label making time. It prints on the largest variety of high quality continuous and die-cut materials up to 50 mm wide and offers an option to have custom materials created.



**i** BMP™21-LAB cartridges can be used in the first generation BMP™21 and LABPAL™ Label Printer.

Features			
Recommended Usage per Day	100	500	1000 50.8x25.4mm labels per day
Resolution (dpi)	203 dpi	300 dpi	300 dpi
Print Technology	Thermal Transfer	Thermal Transfer	Thermal Transfer
Print Speed (mm/sec)	10.00	25.40	38.10
Max Label Width	19.00 mm	38.10 mm	50.80 mm
Text Sizes (pt)	6 - 40	4 - 102	4 - 174
Max Print Width	16.00 mm	36.00 mm	45.97 mm
Bar Code Capability	Code 39 and 128	Code 39 and 128, other via software	Code 39 and 128, other via software
Built-in Symbols	44 symbols included	450 symbols included	500+ symbols included
Flash Memory	Stores 12 labels	48 MB - up to 25,000 labels	200 MB - up to 100,000 labels
Materials Supported	60+ standard parts: continuous tapes	200+ standard parts : continuous tapes and die cut labels	400+ standard parts: continuous tapes, die cut and bulk label rolls, custom made labels and tapes
Stand-alone Printing (Detached from PC)	Stand-alone	Stand-alone & Peripheral	Stand-alone & Peripheral
Colour Capability	Monocolour	Monocolour	Monocolour
Connectivity	-	USB, Bluetooth. Optional: Ethernet, WiFi	USB
Keyboard	ABC	QWERTY	QWERTY, QWERTZ, AZERTY, CYRILLIC
Power Supply	6 AA's, AC Power, Li-ion rechargeable battery	8 AA's, Rechargeable Lithium Ion Battery, AC Power	Rechargeable NiMH Battery, AC Power
Weight (kg)	0.75 kg	1.40 kg	2.49 kg

# Choose Your Printer



**BBP™12 Label Printer**

The BBP™12 Label Printer is an entry level benchtop label printer for cable, component, product and laboratory sample identification that offers great value for money. The compact BBP12 offers a high print speed of 100 mm/second and can handle a wide range of highly durable and specialised Brady identification labels.

**BBP™33 Label Printer**

Completely hassle free, easy to use PC-based printer. Smart chip supplies automatically set up the label in your Brady software. Drop-in ribbon and label cartridges ensure fast and effortless material changes.

**Brady IP™ Printer**

The revolutionary IP™ Printer System - gives you "Hassle Free" printing. The Brady IP Printer is a fully integrated, easy-to-use printer, material, and software system. Smart Cell technology allows the printer, materials, and ribbon to communicate!

**BradyPrinter™ BP-PR Plus Series**

A rugged industrial printer series, meets the demanding need for high volume usage of professional sample identification in laboratories.

Features				
<b>Recommended Usage per Day</b>	500	1000	5000	7000
<b>Resolution (dpi)</b>	300 dpi	300	300 / 600	203 / 300 / 600
<b>Print Technology</b>	Thermal Transfer	Thermal Transfer	Thermal Transfer	Thermal Transfer
<b>Print Speed (mm/sec)</b>	100	101.60	200	254.00
<b>Max Label Width</b>	112 mm	106.00 mm	105.60 mm	116.00 mm
<b>Text Sizes (pt)</b>	–	–	–	–
<b>Max Print Width</b>	105.6 mm	101.60 mm	105.66 mm	105.60 mm
<b>Bar Code Capability</b>	2D and 1D (Linear)	Via software	Via software	Via software
<b>Built-in Symbols</b>	–	–	–	–
<b>Flash Memory</b>	64 MB	4 GB	8 MB	8 MB
<b>Materials Supported</b>	Nylon Cloth, Paper, Polyester, Polyethylene, Polyimide, Polyolefin (Sleeves), Polypropylene, Thermoplastic polyether-polyurethane, Vinyl, Vinyl Cloth, Outdoor Vinyl, Self-laminating Vinyl	Die Cut, Continuous & Custom	Die Cut, Continuous & Custom	Die Cut, Continuous & Custom
<b>Stand-alone Printing (Detached from PC)</b>	Stand-alone & Peripheral	Peripheral	Stand-alone & Peripheral	Stand-alone & Peripheral
<b>Colour Capability</b>	Monocolour	Monocolour	Monocolour	Monocolour
<b>Connectivity</b>	Serial, USB, Ethernet	USB, Ethernet. Optional: WiFi, Bluetooth	USB, Serial, Ethernet. Optional: WiFi	Serial, Parallel, USB, Ethernet
<b>Keyboard</b>	Optional	None	None	None
<b>Hardware Options</b>	Peel & Present, Universal Keyboard	Cutter	Cutter	Cutter, Peel Off
<b>Weight (kg)</b>	2.5 kg	5.30 kg	5.90 kg	8.50 kg

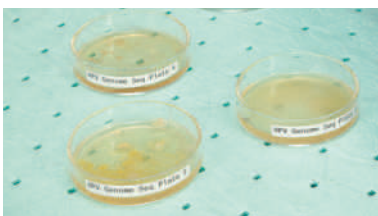

## BMP™21-LAB LABEL PRINTER

TOUGH ON THE OUTSIDE, GENIUS ON THE INSIDE

Combining a tough exterior with smart printing capabilities, the BMP21-LAB hand-held label printer can take a hit and still perform. **Laboratory symbols** & vial/tube auto-sizing, plus drop-lock-and-go cartridges, plus a rechargeable Lithium-ion battery adds up to a powerful and affordable tool for quick and efficient label making in any type of laboratory. **High quality label materials** designed specifically for the laboratory environment create durable, professional looking labels for your laboratory samples and beyond.

### Designed for Laboratory

- Materials available for applications such as cryo vials and slides
- Greek symbols commonly used in laboratory, intuitive menu structure for symbols
- Vial label function automatically cuts the tape according to the size of the vial
- Automated serialisation
- Time & Date stamp

### Easy to use

- 3 line LCD display provides clear visibility
- ABC keypad, graphics library, hot keys and menu functions for fast label creation
- Long life rechargeable Lithium-ion battery\*
- Smart Cell Technology for automatic label setup
- Automatic label formatting for commonly used label types in laboratory
- Magnet accessory\* for more convenient use and storage on smaller laboratory benches and a lanyard for hands-free operation
- Ergonomic, centre balanced printer with grab and go ridges grip for easy handling

### Exceptional material variety and durability

- Laboratory specific materials designed to withstand harsh laboratory environments.
- High quality, long lasting labels that stick and stay stuck
- Prints durable true-sized 6 – 19 mm wide identification to maximise amount of data
- Adjust the length of the labels using the high performance continuous material
- Fulfill your requirements with a range of different industry specified materials that last

## BMP™21-LAB LABEL PRINTER

Art. No.	Description
139538	BMP21-LAB Printer Blister Pack

Blister package contains: Printer, Lanyard, Quick Start Guide, M21-750-7425 label cartridge

## BMP21-LAB STARTER KITS

Art. No.	Description
134474	BMP21-LAB Printer Kit EU
134475	BMP21-LAB Printer Kit UK
134476	BMP21-LAB Printer Kit US

Printer Kit contains: Printer, Li-ion Battery, Power Cord, Lanyard, Quick Start Guide, M21-750-7425 label cartridge



## ACCESSORIES

Art. No.	Description
110416	AC Adaptor - Europe 220V
110417	AC Adaptor - UK 240V
110891	Magnet Only Accessory
110892	Multifunctional Accessory
110937	AC Adaptor - US 110V
139540	Li-ion battery Pack for BMP21-PLUS; BMP21-LAB

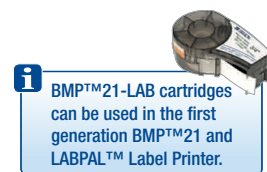

**i** BMP™21-LAB cartridges can be used in the first generation BMP™21 and LABPAL™ Label Printer.

\*Accessories sold separately. Battery included in the Starter Kit only.

## BMP™51 LABEL MAKER

The BMP51 Label Maker is a compact, versatile portable printer with built-in Bluetooth® technology for wireless printing.

- Identify your samples quickly and more efficiently
- Portable/Handheld
- Labels withstand extreme laboratory temperatures and solvents
- Durable built-in cutter that retains the label after it's cut until you need it
- Built-in Bluetooth® or optional Wi-Fi card for wireless printing from a network
- A magnet accessory to keep your printer handy
- Serialisation feature for quicker aliquots



## BMP™51 LABEL MAKER

Art. No.	Order Reference	Description
710932	BMP51-EU-LAB	BMP51 Lab Kit with EU powercord
710894	BMP51 PRINTER EU	BMP51 Printer with Battery Pack - AC Adaptor/Battery Charger EU
710896	BMP51 PRINTER KIT EU-LM	BMP51 Printer with Battery Pack - AC Adaptor/Battery Charger EU & LabelMark
710898	BMP51 PRINTER KIT UK	BMP51 Printer with Battery Pack - AC Adaptor/Battery Charger UK
710900	BMP51 PRINTER KIT UK-LM	BMP51 Printer with Battery Pack - AC Adaptor/Battery Charger UK & LabelMark

## BMP51 ACCESSORIES

Art. No.	Order Reference	Description
142261	UBP-LI-ION-AC-120v	Universal Li-ion Battery Pack with AC Adaptor/Battery Pack US
710902	UBP-LI-ION-AC-EUR	Universal Li-ion Battery Pack with AC Adaptor/Battery Pack EU
710903	UBP-LI-ION-AC-UK	Universal Li-ion Battery Pack with AC Adaptor/Battery Pack UK
114883	M41-50-71-AC-BC-NA	AC Adaptor - USA 120V
710612	M41-50-71-AC-BC-EU	AC Adaptor - Europe 220V
710613	M41-50-71-AC-BC-UK	AC Adaptor - UK 240V
142260	BMP-UBP 12V	Universal Li-Ion Battery Pack
143115	M50-BATT-TRAY	BMP50 Series Spare Battery Tray for 8 AA batteries
143109	M50-HC	BMP50 Series Hard Carry Case
121423	M50-SC	BMP50 Series Soft Carry Case
143108	M50-MAGNET	BMP50 Series Magnet Accessory
142265	NET-BT	Bluetooth Network Card
142268	NET-WIFI-LAN	WiFi/ LAN Network Card
142267	NET-LAN	LAN Network Card
143114	BMP41-BMP50-USB	BMP41-BMP50 Series USB Cable





## BMP™71 PORTABLE LABEL PRINTER

The BMP71 mobile label printer can print on more than 30 different types of label material including several which are specifically suitable for a laboratory environment - all designed with Brady's industrial strength durability.

- The powerful BMP71 prints faster than any other printer in it's class (38 mm/sec). Don't wait longer than necessary for your labels.
- The BMP71 has a full keyboard, available in 4 versions, QWERTY, AZERTY, QWERTZ and CYRILLIC. Use both your hands to type your text instead on one finger and save you time!
- The enlarged colour screen of the BMP71 enables you to see the whole label at once, helping you to compose the label in the most efficient way, eliminating trial and error.
- The BMP71 printer is your essential tool that handles all your label printing needs

**One smart printer to print it all.**



### BMP™71 LABEL PRINTER

Art. No.	Order Reference	Description
710601	BMP71-AZERTY-EU	BMP71 Label Printer with AZERTY Keyboard EU
710604	BMP71-CYRILLIC-EU	BMP71 Label Printer with CYRILLIC Keyboard-EU
710599	BMP71-QWERTY-EU	BMP71 Label Printer with QWERTY Keyboard - EU
710600	BMP71-QWERTY-UK	BMP71 Label Printer with QWERTY keyboard - UK
710603	BMP71-QWERTZ-EU	BMP71 Label Printer with QWERTZ Keyboard-EU

This printer kit ships in a hard case with Rechargeable NiMH Battery, AC Adaptor, USB Communications Cable, TLS2200® / HandiMark™ Material Roll Adaptor, Quick Start Guide, Product CD (w/ Printer Driver, Tutorials, Full User's Guide), Cleaning Kit, M71C-2000-595-WT, M71-31-423 and M71-R6000.

### BMP71 ACCESSORIES

Art. No.	Order Reference	Description
710613	M41-50-71-AC-BC-UK	AC Adaptor - UK 240V
710612	M41-50-71-AC-BC-EU	AC Adaptor - Europe 220V
114883	M41-50-71-AC-BC-NA	AC Adaptor - USA 120V
710615	M71-QC-UK	Quick Charger - UK 240V
710614	M71-QC-EU	Quick Charger - Europe 220V
114884	M71-QC-US	Quick Charger - US 120V
114885	M71-BATT	Spare Battery
114882	M71-SC	Soft Carry Case
114881	M71-HC	Hard-sided Carry Case
114886	M71-CLEAN	Cleaning Kit
147998	M71-ADAPT-BK	Media Adaptor for BMP71 Printer



## BBP™12 LABEL PRINTER

The BBP™12 Label Printer is an entry level benchtop label printer for cable, component, product and laboratory sample identification that offers great value for money. The compact BBP12 offers a high print speed of 100 mm/second and can handle a wide range of highly durable and specialised Brady identification labels.



### SIMPLE, EFFICIENT DESIGN

- Compact in size, fits on every desk
- Default Ethernet Connectivity, allowing you to work in a network
- Connect any universal keyboard via USB 2.0 to work in stand-alone mode
- Full colour LCD Display and intuitive software interface are simple to use, so no extensive training is required
- Simple calibration menu with easy 1-2-3 step printing
- Best price/quality in the market for low volume printing
- Comes with a free unwinder accessory to print larger label rolls

### PERFORMANCE

- Prints a wide range of identification labels from 10 mm up to 112 mm wide
- Standard 300 dpi print quality allowing accurate image & barcode positioning on small labels
- With its powerful 32 bit processor and its extended memory it can print up to 100 mm / sec
- The printer supports the industry-standard Zebra® and Eltron® programming languages
- Print time and date on to your labels via the “Real time clock feature”



While the BBP™12 label printer primarily uses 25.40 mm core materials for low to medium volume printing, an unwinder is available should high volume printing be needed.

### BBP™12 LABEL PRINTER

Art. No.	Order Reference	Description
195566	BBP12-EU+Unwinder	BBP12 Label printer - 300 dpi - EU - with Unwinder
195567	BBP12-UK+Unwinder	BBP12 Label printer - 300 dpi - UK - with Unwinder
195568	BBP12-US+Unwinder	BBP12 Label printer - 300 dpi - US - with Unwinder
195569	BBP12-EU+U+LM PRO	BBP12 Label printer - 300 dpi - EU - with Unwinder and LabelMark6 Pro software
195570	BBP12-UK+U+LM PRO	BBP12 Label printer - 300 dpi - UK - with Unwinder and LabelMark6 Pro software
195571	BBP12-US+U+LM PRO	BBP12 Label printer - 300 dpi - US - with Unwinder and LabelMark6 Pro software

### ACCESSORY

Art. No.	Order Reference	Description
361064	BBP12/BBP11-VP	Peel and Present





## BBP™33 LABEL PRINTER

The BBP33 Label Printer is a completely hassle free, easy to use PC-based printer that can print signs and labels up to 101.60 mm wide. Smart chip supplies automatically set up the label in your Brady software, eliminating manual calibration and label waste. Drop-in ribbon and label cartridges ensure fast and effortless material changes. The BBP33 Label Printer can print on a full range of laboratory labels and provides you clear and durable labelling to eliminate errors in sample identification and ensure traceability.

- Eliminate errors in sample identification and ensure traceability with clear and durable labelling
- Fits best in your laboratory environment due to its small footprint
- Label materials withstand extreme conditions, including freezer storage, liquid nitrogen and hot water baths
- Automatic label setup with no calibration
- Fast and effortless material changeovers
- Prints correctly on the first label!



## BBP™33 LABEL PRINTER

Article No.	Order Reference	Description
711071	BBP33 EU Printer	BBP33 Label Printer - EU
711072	BBP33 EU Printer + LM	BBP33 Label Printer - EU with LabelMark Software
711073	BBP33 EU Printer + MW	BBP33 Label Printer - EU with MarkWare Software
711074	BBP33 EU Printer + LM & MW	BBP33 Label Printer - EU with LabelMark and MarkWare Software
711075	BBP33 UK Printer	BBP33 Label Printer - UK
711076	BBP33 UK Printer + LM	BBP33 Label Printer - UK with LabelMark Software
711077	BBP33 UK Printer + MW	BBP33 Label Printer - UK with MarkWare Software
711078	BBP33 UK Printer + LM & MW	BBP33 Label Printer - UK with LabelMark and MarkWare Software

BBP33 Label Printer ships with printer, power cord, USB cable, drivers CD, cleaning kit and quick start guide.

## BBP33 ACCESSORIES

Article No.	Order Reference	Description
120994	B30-TROLLEY	Trolley for BBP30, BBP31 and BBP33
142114	B30-WIPER	Media Wiper 5 Pack
142116	B30-CCT	Cutter Cleaning Tool for BBP30, BBP31 and BBP33
142267	NET-LAN	LAN Network Card
142268	NET-WIFI-LAN	WIFI/ LAN Network Card



To find out how Brady helps some of the world's leading research laboratories develop more efficient labelling protocols visit [www.bradyeurope.com/labid](http://www.bradyeurope.com/labid)



## BRADY IP™ SERIES PRINTER

**LOAD. CLICK. PRINT.**  
**HIGH PERFORMANCE PRINTING**  
**MADE FASTER AND SIMPLER.**

The Brady IP Printer redefines power and ease-of-use in thermal transfer printing. Our most popular benchtop solution, the IP utilises smart chip technology allowing the printer, ribbon, material roll and PC software to communicate which significantly reduces set up time, reduces change-out time and reduces calibration label waste. Get ready for fast hassle-free printing.

### FASTER CHANGE-OUTS AND LESS WASTE

- Load Brady material and the software automatically recognises it
- No more calibration or material waste required for notched, die-cut or continuous materials
- Super-easy ribbon and material loading with centre-justified guides and straight feed path
- Hassle-free drop-in material rolls install in a snap

### MORE PERFORMANCE

- Designed for up to 5000 labels per day at 8 hrs / 5 days per week operation
- Fast print speed – up to 200 mm/sec
- Prints on a vast selection of material varieties and materials, including custom-made parts
- LCD display shows correct material/ribbon match, visual sensor position and “material and ribbon remaining”

### HASSLE-FREE OPERATION

- Fast hassle-free change-outs makes IP ideal for high-mix users (those using multiple material parts & put-ups)
- Perfect for users who are new to thermal transfer printing



## BRADY IP™ SERIES PRINTER

Article No.	Order Reference	Description
<b>300 dpi</b>		
360814	BP-THT-IP300-EU	IP Printer - 300 dpi - 220 V
360815	BP-THT-IP300-C-EU	IP Printer - 300 dpi with Cutter- 220 V
360844	BP-THT-IP300-UK	IP Printer - 300 dpi - 240 V
360845	BP-THT-IP300-C-UK	IP Printer - 300 dpi with Cutter - 240 V
361080	BP-THT-IP300-WLAN-EU	IP Printer - 300 dpi with WIFI - English
<b>600 dpi</b>		
360817	BP-THT-IP600-EU	IP Printer - 600 dpi - 220 V
360818	BP-THT-IP600-C-EU	IP Printer - 600 dpi with Cutter - 220 V
360847	BP-THT-IP600-UK	IP Printer - 600 dpi - 240 V
360848	BP-THT-IP600-C-UK	IP Printer - 600 dpi with Cutter - 240 V
361081	BP-THT-IP600-WLAN-EU	IP Printer - 600 dpi with WIFI - English

## BRADY IP PRINTER ACCESSORIES

Art. No.	Order Reference	Description
133251	PCK-6	Printer Cleaning Kit - Thermal Transfer Printers
361082	WLAN-Card 802.11b/g	Wireless Ethernet Card for Brady IP Printer



## BRADYPRINTER PR PLUS THERMAL TRANSFER PRINTER

The BradyPrinter™ model BP-PR PLUS series is a rugged industrial printer range that is an ideal printing solutions that meets the professional needs of Product Identification and Traceability applications in the laboratory environment. The BP-PR PLUS also allows frequent change for materials which use different core diameters, yet maintain critical print registration.

### FEATURES

- Stand-Alone Mode
- Easy Calibration
- Easy change of material core sizes
- Heat Management
- Large Graphic Display
- Navigator Pad
- Easy Programming Language
- Wide Material Range



## BRADYPRINTER PR PLUS THERMAL TRANSFER PRINTER

Article No.	Order Reference	Description
203 dpi		
360540	BP-PR200Plus	BradyPrinter 203 dpi Printer - 220V
360541	BP-PR200Plus-P	BradyPrinter 203 dpi Printer - 220V - Peel Off
360588	BP-PR200Plus-UK	BradyPrinter 203 dpi Printer - 240V
360589	BP-PR200PLUS-P-UK	BradyPrinter 203 dpi Printer - 240V - Peel Off
300 dpi		
360542	BP-PR300Plus	BradyPrinter 300 dpi Printer - 220V
360543	BP-PR300Plus-P	BradyPrinter 300 dpi Printer - 220V - Peel Off
360590	BP-PR300Plus-UK	BradyPrinter 300 dpi Printer - 240V
360591	BP-PR300Plus-P-UK	BradyPrinter 300 dpi Printer - 240V - Peel Off
360925	BP-PR360Plus	BradyPrinter Model PR360 Plus Printer
360926	BP-PR360Plus-P	BradyPrinter Model PR360 Plus Printer - Peel Off
600 dpi		
360544	BP-PR600Plus	BradyPrinter 600 dpi Printer - 220V
360545	BP-PR600Plus-P	BradyPrinter 600 dpi Printer - 220V - Peel Off
360592	BP-PR600Plus-UK	BradyPrinter 600 dpi Printer - 240V
360593	BP-PR600Plus-P-UK	BradyPrinter 600 dpi Printer - 240V - Peel Off

## BRADYPRINTER PR PLUS ACCESSORIES

Article No.	Order Reference	Description
133251	PCK-6	Printer Cleaning Kit - Thermal Transfer Printers
360007	Cutter CU4 - field installable	Cutter CU4 - field instble
360008	Cutter Tray 4 - field instible	Cutter Tray 4 - field instible
360009	External Rewinder ER1, Roll diam. 210 mm - field instible	External Rewinder ER1, Roll diam. 210 mm - field instible
360010	External Rewinder ER4/300 - field instible	External Rewinder ER4/300 - field instible
360011	External Unwinder EU4, Roll diam. 300 mm - field instible	External Unwinder EU4, Roll diam. 300 mm - field instible
360014	Transcend 512MB Compact Flash Card	Transcend 512MB Compact Flash Card
360015	USB Interface w/ cable 1.8 m - field instible	USB Interface w/ cable 1.8 m - field instible
360016	Fast Ethernet Interface - field instible	Fast Ethernet Interface - field instible
360017	Cable serial RS 232C, 9/9-pin, length 3 m	Cable serial RS 232C, 9/9-pin, length 3 m
360018	USB Cable	USB Cable
360019	Present Sensor PS 8 - manual operation - field instible	Present Sensor PS 8 - manual operation - field instible
360020	Present Sensor PS 6 - automatic operation - field instible	Present Sensor PS 6 - automatic operation - field instible
360923	PCU/4	Perforation Cutter PCU/4

## BSP™31 LABEL ATTACHMENT SYSTEM

- Brady has developed a unique set of products for the histology and anatomic pathology market in order to guarantee pre-process identification for tissue samples allowing traceability throughout laboratory processes as well as long term storage (< 20 years).
- The BSP™31 Label Attachment System is designed to mechanically fasten an adhesive label to a tissue cassette before the tissue embedding process. This easy-to-use unit creates rivets on the label which prevent the label from detaching during the embedding process or during long-term storage
- When a cassette is inserted into the front of the unit, a clamp automatically grabs the cassette. In less than a minute, four small heat probes pierce through the label and front plastic of the cassette. Heat applied to the probes melts the cassette plastic and forms rivets on the label. When the unit retracts the probes from the cassette, the cassette is released and the user can remove it and place the biospecimen onto the cassette.
- The BSP™31 unit must be used exclusively with Brady B-482 label material and the R6400 thermal transfer printer ribbon.



Art. No.	Order Reference	Description
804850	BSP31 LABEL ATTACHMENT SYSTEM EUROPE	BSP31 Suitable for Europe and UK
804855	BSP31 -KIT LIGHT EUR	BSP31 Light Kit Europe version - 220V
804856	BSP31 -KIT LIGHT UK	BSP31 Light Kit UK version - 240V
804858	BSP31 -KIT FULL EUR	BSP31 Full Kit Europe version - 220V
804859	BSP31 -KIT FULL UK	BSP31 Full Kit UK version - 240V
114631	BRUSH KIT,BSP31	Cleaning Brushes for the BSP31
804866	ASSY FILTER BSP31 RC	Filter for the BSP31

Light Kit: BSP31 Label Attachment System, BBP12 300 dpi Printer, Codesoft Basic

Full Kit: BSP31 Label Attachment System, BBP12 300 dpi Printer, Codesoft Basic, CR1400 bar code reader with 1.83 m USB cable, Thermal Transfer Printable Labels BPT-164-481 & THT-199-482-3-SC, Black Thermal Transfer Printer Ribbon R6400 65mm x 70m /O



### B-482 Tissue cassette labels

“We have received very positive feedback on the Brady cassette labels from researchers. They report that, as well as looking much more professional, the printed labels save time when they need to search through their archived blocks for a particular sample. Black text printed on a white label is very much quicker and easier to read than pencil on a green cassette. The clear labels therefore eliminate any confusion or mistakes which could occur with handwritten data.”

**Cardiff University – School of Biosciences, UK**



### B-498 Re-Identify Tissue Cassettes Labels

Tissue cassettes are often re-identified when labs collect samples from various biorepositories. Typically, each laboratory has its own unique way of identifying samples, which creates a need to re-identify samples in a common way.

Brady B-498 post-process labels offer customers the optimal way to organise these specimens and conduct further studies. These labels can be applied directly onto the cassettes, on pure paraffin wax and on top of another label or identifier.

This is not the same as Brady's B-482 tissue cassette solution. B-498 Re-identify labels are applied after processing and are never used with the BSP31 label attachment system.





## LABELMARK™ LABORATORY LABELLING SOFTWARE

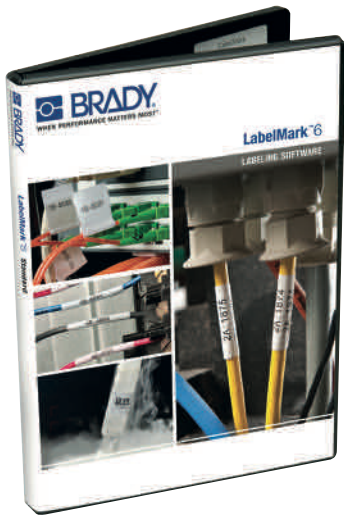

LabelMark software features a lab-friendly interface and hundreds of parts and graphics categorised by common laboratory applications making creating legible, durable and accurate labels quick and easy.

- Easy-to-use Lab Application to create new files and templates
- Superscript and subscript characters
- Database import capabilities with refresh feature to ensure data integrity
- 2D bar coding and linear bar coding
- Multi-label data entry view
- Compatibility with a variety of Brady printers including BMP51, BMP71, BBP12, BBP33, IP, and BP-PR Plus as well as all Windows®-based printers
- 2-way communication with Brady printers, enabling automatic label recognition, selection and setup

## BRADY WORKSTATION DATA AUTOMATION

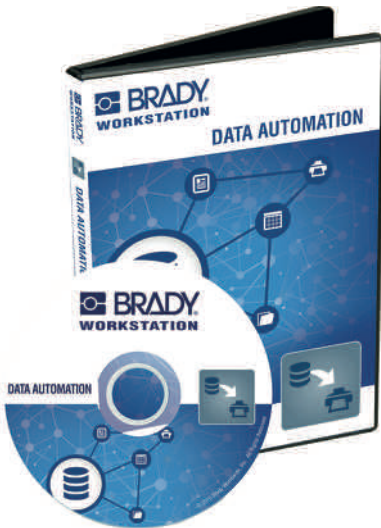

Use the Brady Workstation Data Automation app to set up automated sample label printing using information from a LIMS. Data Automation uses LabelMark™ 6 label templates and .csv – exports from an ERP system such as LIMS. It enables the setup of several print channels that send preselected information to a predetermined label template which can be printed on a printer of choice, loaded with the correct consumables. Once set up, Data Automation can automatically print a sample label when a LIMS receives information on a newly arrived sample.

## CODESOFT™ LABEL CREATION SOFTWARE

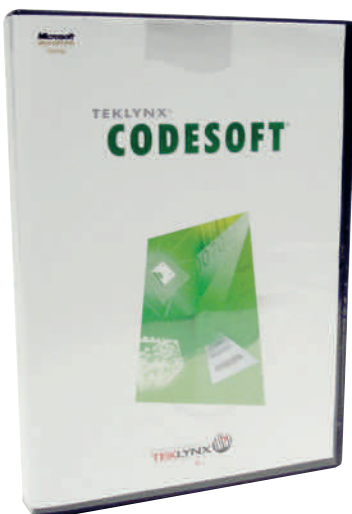

CodeSoft is a very powerful, feature-rich design software. It has the most text editing and bar code features, plus it is the best choice for advanced database importation and integration with 3rd party software programs - like LIMS.

- Over 100 Bar code symbologies including linear and 2D
- Robust data sourcing capabilities
- View labels and data in the same screen
- Label Comparison tool for previewing labels at design or production stages
- OLE automation supports object integration from any 3rd party Windows® application
- Enhanced Shape Tool makes using graphics and shapes on your labels a snap
- CodeSoft Pro - is for users printing text, images and bar codes on one to three printers
- CodeSoft Enterprise - is for user printing from databases and existing systems
- CodeSoft Network - is for users who want to manage licenses from a server

## CODE READER® SCANNERS

Scanners improve sample tracking, eliminate human error and save an enormous amount of time during both labelling and retrieving samples.

Code Reader Scanners combines the industry's best imaging technology with a graphic display and rugged keyboard that makes this new standard in small, fast user-friendly data and inventory management. Now the best portable all-symbology bar code reader in the industry is even more versatile, with the addition of information display and keyboard entry functions.

### THERE ARE 2 INTERFACE OPTIONS:

#### Cabled (Basic)

Plug-an-play interface. Available with USB (standard), PS2 or RS232 interfaces. All cables use rugged automatic locking adapters that allow users to change cables while preventing inadvertent disconnections.

#### Batch (Basic + Battery)

Cables and Store and Forward capacity in one unit. Simply detach the scanner from the computer, capture data remotely and reconnect to the computer. When reconnected, the scanner will automatically download data to the active application. When connected via the included USB cable, the unit operates as a standard keyboard wedge.

### BENEFITS OF BAR CODING AND SCANNING







- Quickly identify and retrieve samples
- Eliminate human error with log-in and inventory data entry
- Accurately track samples and chemicals from receipt to disposal
- Automatically update sample information

#### Take advantage of the following features:

- Dual field optics, both high density and wide field in the same unit
- Glare reduction technology for reading codes on shiny surfaces
- Reads all linear, stacked and 2D matrix symbologies
- Dynamic Optimisation Technology



## LINEAR VS. 2-DIMENSIONAL BAR CODES

7 mil Examples	10 mil Examples	Symbol Size (mm) Row x Column	Bar Code Data Capacity		Built-in Error Correction
			Numeric	Alphanumeric	
 3.43 mm / 2D / Data Matrix Bar Code	 4.57 mm / 2D / Data Matrix Bar Code	18 x 18	36	25	YES (ECC200)
 4.95 mm / 2D / Data Matrix Bar Code	 6.60 mm / 2D / Data Matrix Bar Code	26 x 26	88	64	YES (ECC200)
 25.40 mm / Linear / Code 128 Bar Code	 31.75 mm / Linear / Code 128 Bar Code	31.75	10	10	NO

## CODE READER™ 1400

The CR1400 is a compact, rugged barcode reader that features a high performance scan engine and intuitive targeting that makes reading 1D and 2D barcodes extremely fast, reliable and affordable.

- High speed, omnidirectional reading of 1D and 2D barcodes
- Patented dual field optics, both high density and wide field in the same unit
- Glare reduction technology for reading codes on shiny surfaces
- Manual or automatic triggering
- 3 programmable indicators: vibration mode, LED and tone
- Data editing and parsing with JavaScript
- Disinfectant ready, IP54 housing



Article No.	Description
361109	CR1400 Scanner with 1.83 m USB cable
361103	Metal stand and Base for CR1400 Scanner



Code Reader™ is a registered trademark of Code Corporation.



## CODE READER™ 2600

The CR2600 is an easy to use, lightweight, and high performing barcode reader that reads all 1D and 2D barcode symbologies. Featuring a durable, rechargeable battery plus programmable buttons for a custom workflow, it sets the standard in barcode reading technology.

- Battery status LED indicators with fuel gauge
- Programmable user feedback with vibration, audible tones and LED
- Patented dual field optics, both high density and wide field in the same unit
- High speed, omnidirectional reading of 1D and 2D barcodes
- Unequalled performance on rounded, curved and shiny surfaces
- Multiple programmable buttons for customised work flow processes
- Easy to clean, disinfectant ready, IP65 housing for healthcare use
- Powerful data management capability with JavaScript

Article No.	Description
134441	CR2600, Handle, Bluetooth, Charging Station with Embedded Modem, USB Charge Cable
134442	CR2600, Palm, Bluetooth, Charging Station with Embedded Modem, USB Charge Cable

### Accessories

Article No.	Description
134443	CR2600 Battery
134444	0.92m Mini-USB Charging Cable (USB to Mini-USB)
134445	CR2600 Charging Station with Embedded Modem, 0.92m USB Charge cable
134446	CR2600 Base/adaptor plate



## CODE READER™ 3600

The CR3600 sleek, wireless scanner has a colour screen and keypad that allows users to manually enter data in real time. The screen provides a mobile solution for users who need instant visibility to scanned information, the device handles every type of mobile barcode need.

- Bright colour display screen
- Lightweight models in palm and handled configurations
- Durable, quick-release rechargeable battery cartridges
- Battery status LED indicators with fuel gauge
- User feedback with vibration, audible tones and LED
- High speed, omnidirectional reading of 1D, 2D barcodes
- Multiple programmable buttons for customised work flow processes
- IP54 housing securely protects electronics and optics
- Powerful data management capability with JavaScript
- Compatible with Bluetooth supported Android, iOS, and Windows mobile devices and tablets

Article No.	Description
138472	CR3600 dark grey scanner with handle, bluetooth, battery and a charging station with embedded modem and a 1M USB charge cable
138473	CR3600 dark grey Palm scanner with bluetooth, battery and a charging station with embedded modem and a 1M USB charge cable

### Accessories

Article No.	Description
138474	CR3600 charging station with embedded modem and a 1M USB charge cable
138475	CR3600 B4 dark grey battery

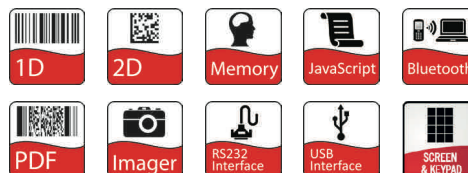

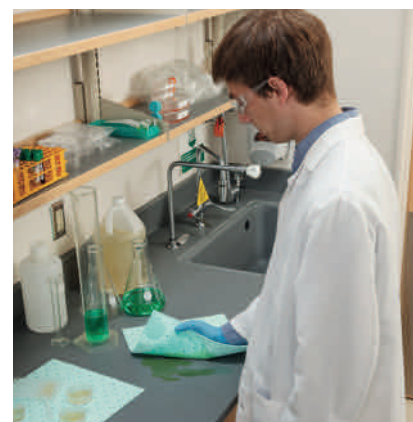

## Miscellaneous Products

Hazardous Substance Identification .....	52
Sorbent Products .....	54
Pipemarkers .....	58
Safety Signs on Rolls .....	58



## ALL CHEMICALS LABELLED?

CLP is a mandatory European Union regulation which requires, amongst other obligations, the clear identification of products containing dangerous chemicals.

The EU's CLP regulation is based on the United Nation's Globally Harmonised System for chemical substances and, from June 2015 onwards, compliance to CLP is required for dangerous chemicals and mixtures in all EU member states. Every substance listed as dangerous, and every mix containing one of these dangerous substances, also needs to carry a CLP label as of June 2015.



## WHAT IS CLP

Classification, Labelling and Packaging (CLP) of substances and mixtures is the EU Regulation 1272/2008 which is an EU-wide system for classifying and labelling chemicals.

The system adopts the United Nations' Globally Harmonised System, or GHS.

- The GHS/CLP symbols were introduced in the EU on the basis of the CLP/GHS regulation (Classification, Labelling and Packaging) in January 2009.
- **GHS/CLP replaces the HSID labelling:** The orange coloured hazardous materials pictograms used until now are being replaced with new diamond-shaped pictograms on a white background with a red border. The current R+S Statements will be replaced by H+P Statements (+ EUH Statements). In the EU, it has been required since 01.12.2010 to label **chemical substances** in accordance with the regulation. As from 01.06.2015 this requirement also applies to **chemical mixtures**. In the CLP/GHS the signal words "Danger" and "Warning" must be used, in accordance with the substance.

## WHY DOES GHS MATTER?

**Chemical import/export means big business**

Globally, the production and use of chemicals is a more than 1.5 trillion € per year enterprise (340€ billion in the U.S. alone). Chemical labelling has appeared differently based on different regional requirements. With such an impact on the world economy, it's critical that the import and export of chemicals be made as safe and efficient as possible.

The GHS standard globally helps keep workers safe and informed of chemical hazards.

## PRE-PRINTED LABELS WITH CLP/GHS SYMBOLS

Brady has a wide range of pre-printed labels to identify your chemical containers.

- High quality labels that can withstand the toughest environments
- Ultra-durable materials mean you only need to label products once in their lifetime
- Extremely weather, abrasion and chemical resistant
- Labels can withstand temperatures of -40 °C to +120 °C

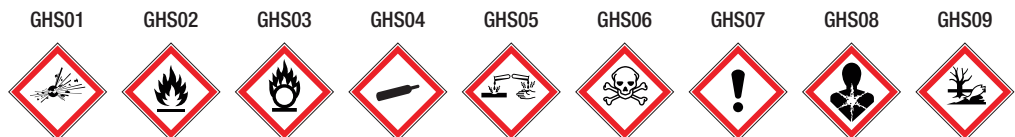

Width x Height	Layout	PIC 1801	PIC 1802	PIC 1803	PIC 1804	PIC 1808	PIC 1809	PIC 1805	PIC 1807	PIC 1806
		Explosive	Flammable	Oxidizing	Compressed Gas	Corrosive	Acute Toxicity	Health Hazard	Respiratory Hazard	Hazardous to Aquatic Environment
50 mm x 50 mm	Continuous Roll	811681	811686	811691	811696	811716	811721	811701	811711	811706
50 mm x 50 mm	Individual Markers on a Roll	814032	814033	814034	814035	814039	814040	814036	814038	814037
100 mm x 100 mm	Continuous Roll	814023	814024	814025	814026	814030	814031	814027	814029	814028
100 mm x 100 mm	Individual Markers on a Roll	811679	811684	811689	811694	811714	811719	811699	811709	811704



## PRE-PRINTED GHS/CLP CHEMICAL LABELS

PRINT 2 COLOUR GHS LABELS IN ONE FAST PRINT PASS!

- Blank labels with pre-printed red diamonds allow printer to produce 2 colour GHS/CLP labels in one print pass
- 3 sizes of labels, each with 6 different diamond layouts that match templates in MarkWare™ Software 3.9.1 or higher. Visit [www.bradyeurope.com](http://www.bradyeurope.com) or contact your Brady distributor for more information
- Indoor/outdoor vinyl material withstands exposure to moisture, chemicals and handling



### Pre-printed GHS/CLP Labels for BBP™12 Label Printer

Diagram	Order Reference	Layout	Label Width A (mm)	Label Height B (mm)	Vertical Repeat D (mm)	Web Width E (mm)	Labels per Row	Labels per Package	Ribbon Series
<b>B-7610: Paper</b>									
▲	THTCLP-S-L1-7610-0.4-SC	L1	55.00	85.00	91.02	59.00	1	400	R7950
▲	THTCLP-S-L2-7610-0.4-SC	L2	55.00	85.00	91.02	59.00	1	400	R7950
▲	THTCLP-S-L3A-7610-0.4-SC	L3A	55.00	85.00	91.02	59.00	1	400	R7950
▲	THTCLP-S-L3B-7610-0.4-SC	L3B	55.00	85.00	91.02	59.00	1	400	R7950
▲	THTCLP-S-L4A-7610-0.4-SC	L4A	55.00	85.00	91.02	59.00	1	400	R7950
▲	THTCLP-S-L4B-7610-0.4-SC	L4B	55.00	85.00	91.02	59.00	1	400	R7950
▲	THTCLP-M-L1-7610-0.3-SC	L1	75.00	110.00	115.36	79.00	1	300	R7950
▲	THTCLP-M-L2-7610-0.3-SC	L2	75.00	110.00	115.36	79.00	1	300	R7950
▲	THTCLP-M-L3A-7610-0.3-SC	L3A	75.00	110.00	115.36	79.00	1	300	R7950
▲	THTCLP-M-L3B-7610-0.3-SC	L3B	75.00	110.00	115.36	79.00	1	300	R7950
▲	THTCLP-M-L4A-7610-0.3-SC	L4A	75.00	110.00	115.36	79.00	1	300	R7950
▲	THTCLP-M-L4B-7610-0.3-SC	L4B	75.00	110.00	115.36	79.00	1	300	R7950
▲	THTCLP-L-L1-7610-0.2-SC	L1	105.00	155.00	160.12	109.00	1	200	R7950
▲	THTCLP-L-L2-7610-0.2-SC	L2	105.00	155.00	160.12	109.00	1	200	R7950
▲	THTCLP-L-L3A-7610-0.2-SC	L3A	105.00	155.00	160.12	109.00	1	200	R7950
▲	THTCLP-L-L3B-7610-0.2-SC	L3B	105.00	155.00	160.12	109.00	1	200	R7950
▲	THTCLP-L-L4A-7610-0.2-SC	L4A	105.00	155.00	160.12	109.00	1	200	R7950
▲	THTCLP-L-L4B-7610-0.2-SC	L4B	105.00	155.00	160.12	109.00	1	200	R7950
<b>B-7594: Polypropylene</b>									
▲	THTCLP-S-L1-7594-0.4-SC	L1	55.00	85.00	91.02	59.00	1	400	R6000
▲	THTCLP-S-L2-7594-0.4-SC	L2	55.00	85.00	91.02	59.00	1	400	R6000
▲	THTCLP-S-L3A-7594-0.4-SC	L3A	55.00	85.00	91.02	59.00	1	400	R6000
▲	THTCLP-S-L3B-7594-0.4-SC	L3B	55.00	85.00	91.02	59.00	1	400	R6000
▲	THTCLP-S-L4A-7594-0.4-SC	L4A	55.00	85.00	91.02	59.00	1	400	R6000
▲	THTCLP-S-L4B-7594-0.4-SC	L4B	55.00	85.00	91.02	59.00	1	400	R6000
▲	THTCLP-M-L1-7594-0.3-SC	L1	75.00	110.00	115.36	79.00	1	300	R6000
▲	THTCLP-M-L2-7594-0.3-SC	L2	75.00	110.00	115.36	79.00	1	300	R6000
▲	THTCLP-M-L3A-7594-0.3-SC	L3A	75.00	110.00	115.36	79.00	1	300	R6000
▲	THTCLP-M-L3B-7594-0.3-SC	L3B	75.00	110.00	115.36	79.00	1	300	R6000
▲	THTCLP-M-L4A-7594-0.3-SC	L4A	75.00	110.00	115.36	79.00	1	300	R6000
▲	THTCLP-M-L4B-7594-0.3-SC	L4B	75.00	110.00	115.36	79.00	1	300	R6000
▲	THTCLP-L-L1-7594-0.2-SC	L1	105.00	155.00	160.12	109.00	1	200	R6000
▲	THTCLP-L-L2-7594-0.2-SC	L2	105.00	155.00	160.12	109.00	1	200	R6000
▲	THTCLP-L-L3A-7594-0.2-SC	L3A	105.00	155.00	160.12	109.00	1	200	R6000
▲	THTCLP-L-L3B-7594-0.2-SC	L3B	105.00	155.00	160.12	109.00	1	200	R6000
▲	THTCLP-L-L4A-7594-0.2-SC	L4A	105.00	155.00	160.12	109.00	1	200	R6000
▲	THTCLP-L-L4B-7594-0.2-SC	L4B	105.00	155.00	160.12	109.00	1	200	R6000

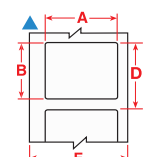

L1

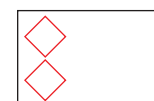

L2

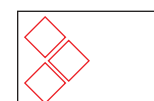

L3A



L3B

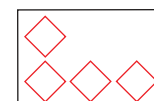

L4A

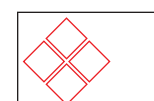

L4B

### Pre-printed GHS/CLP Labels for BBP™33 Label Printer

Diagram	Order Reference	Layout	Label Width A (mm)	Label Height B (mm)	Labels per Row	Labels per Package	Ribbon Series
<b>B-7569: Vinyl</b>							
▲	B30-260-7569-CLP1	L1	55.00	85.00	1	340	B30-R10000
▲	B30-260-7569-CLP2	L2	55.00	85.00	1	340	B30-R10000
▲	B30-260-7569-CLP3A	L3A	55.00	85.00	1	340	B30-R10000
▲	B30-260-7569-CLP3B	L3B	55.00	85.00	1	340	B30-R10000
▲	B30-260-7569-CLP4A	L4A	55.00	85.00	1	340	B30-R10000
▲	B30-260-7569-CLP4B	L4B	55.00	85.00	1	340	B30-R10000
▲	B30-261-7569-CLP1	L1	75.00	110.00	1	270	B30-R10000
▲	B30-261-7569-CLP2	L2	75.00	110.00	1	270	B30-R10000
▲	B30-261-7569-CLP3A	L3A	75.00	110.00	1	270	B30-R10000
▲	B30-261-7569-CLP3B	L3B	75.00	110.00	1	270	B30-R10000
▲	B30-261-7569-CLP4A	L4A	75.00	110.00	1	270	B30-R10000
▲	B30-261-7569-CLP4B	L4B	75.00	110.00	1	270	B30-R10000
▲	B30-262-7569-CLP1	L1	105.00	155.00	1	200	B30-R10000
▲	B30-262-7569-CLP2	L2	105.00	155.00	1	200	B30-R10000
▲	B30-262-7569-CLP3A	L3A	105.00	155.00	1	200	B30-R10000
▲	B30-262-7569-CLP3B	L3B	105.00	155.00	1	200	B30-R10000
▲	B30-262-7569-CLP4A	L4A	105.00	155.00	1	200	B30-R10000
▲	B30-262-7569-CLP4B	L4B	105.00	155.00	1	200	B30-R10000



## SPILL SAFETY STATIONS

- Easy to locate and identify from all angles
- Find essential spill safety items in one place
- Instantly notice when stock is running low
- Easy to install
- **Gloves, disposal bags, tear-off absorbent pads:** essential items to clean up spills safely and quickly dispose of them
- **Best practice guide:** 10 best practice steps on how to deal with a spill safely

Order Reference	Article No.	Description	Quantity
SS-EMP	134431	SPC Spill Station Empty	1

There are two types of Spill Safety Station to help you respond to different kinds of spill. Each station can be supplied with or without Economy Spill Kit.

### Spill Stations

Order Reference	Article No.	Description	Quantity
SS-MRO	134434	SPC Spill Station Chem, English version	1 Kit
SS-UN	134437	SPC Spill Station Universal, English version	1 Kit

### Spill Stations With Economy Spill Kit

Order Reference	Article No.	Description	Quantity
SS-MRO-GRAB	134435	SPC Spill Station Chem & Grab, English version	1 Kit
SS-UN-GRAB	134436	SPC Spill Station Universal & Grab, English version	1 Kit

**i** Yellow disposal bags can be ordered separately.  
Article number: 834179 - Order Reference: BAG-DIS-YEL



## SPILL RESPONSE PLUS

Spill Response Plus is a smaller size pad and roll designed to be highly absorbent, durable, low lint and to reduce waste.

- Dimpled design provides better looking, strong and durable product
- Roll is perforated so you only use what you need
- Includes universal (grey) and chemical (green) applications
- **Perfect to be used with Spill Safety Stations**

Order Reference	Article No.	Description	Colour	Total Qty/ Pack	Absorption Capacity (Ltrs)
MRO365-P	834176	ROLL, universal, 19 cm x 15 m, Heavy weight, perforated & bonded, 60 pads per roll	Grey	1 Roll(s) / Bag	15
UN365-P	834177	ROLL, chemical absorbency, 19 cm x 15 m Perforated, 60 pads per roll	Green	1 Roll(s) / Bag	12



## SKH-MINI

A FULLY DISPOSABLE SPILL KIT TO CLEAN UP SMALL CHEMICAL SPILLS EASILY AND WITHOUT RISK OF INJURIES.

- The autoclavable disposal bag is heat resistant up to 145°C to guarantee safe disposal of laboratory waste.
- Suited for spills of up to 1.7 litres, absorbing chemicals, water & oil based fluids.
- The specially designed disposable brush is intended to sweep up any broken glass or debris allowing a safe clean up without risk of injuries.
- Compact design: the SKH-MINI can easily be placed in any areas where it is most needed.
- Protective gloves are powder free, have roughened fingertips, increased tear resistance and a good chemical resistance for more safety.

**Contents:** 2 pads (41 cm x 51 cm), 1 pair of disposable chemical protective gloves, 1 autoclavable disposal bag, 1 disposable brush and 1 multilingual instruction guide.

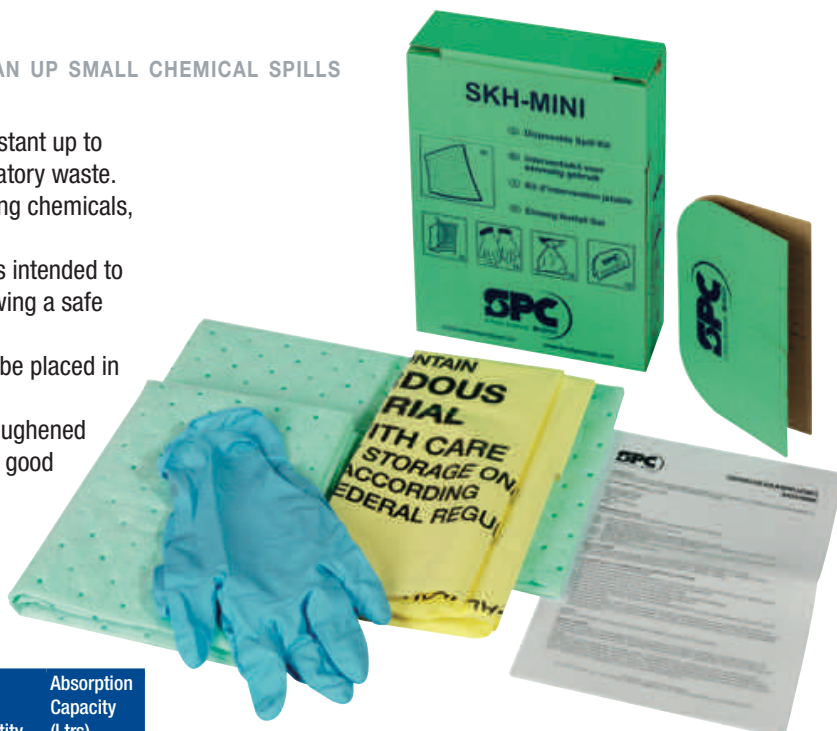

Order Reference	Article No.	Description	Quantity	Absorption Capacity (Ltrs)
SKH-MINI	813868	Disposable spill kit, chemical	4 Kits/Box	6.80*

\*4 x 1.7 litres

## HAZWIK PILLOWS

FOR ABSORBING SPILLS & LEAKING LIQUIDS IN TIGHT SPACES.

- Absorb chemicals, acids & bases.
- Good for large spills once contained.
- Ideal for use in packaging for extra protection during transport.
- 2 different sizes to fit any application.

Order Reference	Article No.	Description	Total Qty/Pack	Absorption Capacity (Ltrs)
HAZ1818	813853	Pillow, 43 cm x 48 cm	16 Piece(s) / Box	105
HAZ1818-2	813854	Pillow, 43 cm x 48 cm	8 Piece(s) / Box	53
HAZ99	813855	Pillow, 23 cm x 23 cm	32 Piece(s) / Box	58



Protection of fragile liquids during transport.





## UN Booms

THE BEST WAY TO ABSORB AND CONTAIN LARGE SPILLS OF CHEMICALS AND HAZARDOUS LIQUIDS.

- Absorb chemicals, acids & bases as well as oils and water-based liquids.
- Metal clips & rings allow for easy linking of booms.
- Inner rope secured with four clips provides strength.
- Strong outer sleeve for durability.
- Inner sleeve keeps the adsorbent material intact within the boom.

Order Reference	Article No.	Description	Total Qty/Pack	Absorption Capacity (Ltrs)
UN810	813848	Boom, Ø 20 cm x 3 m	4 Piece(s) / Bag	263
UN510	813849	Boom, Ø 13 cm x 3 m	4 Piece(s) / Bag	118

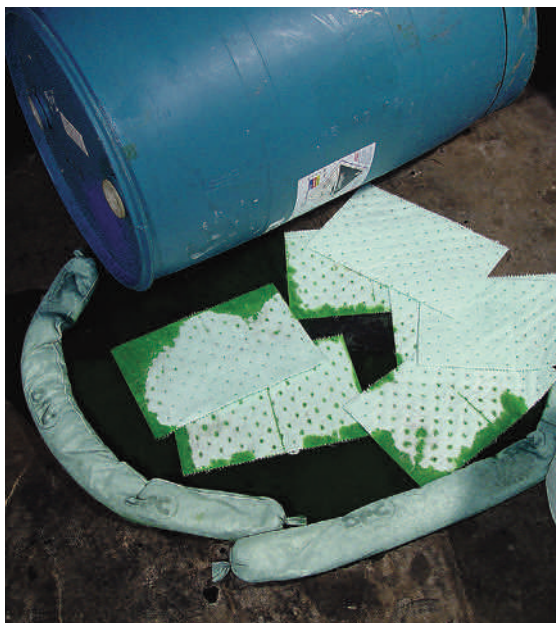

## Hazwik Socs

CONFINE & PREVENT HAZARDOUS SPILLS FROM SPREADING.

- Absorb chemicals, acids & bases.
- Different lengths available to always have the right size for your application.
- Flexible design is easily moulded around machines and spills.

Order Reference	Article No.	Description	Total Qty/Pack	Absorption Capacity (Ltrs)
HAZ412	813850	Soc, Ø 7.6 cm x 122 cm	12 Piece(s) / Box	45
HAZ806	813851	Soc, Ø 7.6 cm x 244 cm	6 Piece(s) / Box	48
HAZ124	813852	Soc, Ø 7.6 cm x 366 cm	4 Piece(s) / Box	45



## UN PADS & ROLLS

FOR USE WHEN CHEMICALS AND HAZARDOUS LIQUIDS ARE INVOLVED!

- Chemically inert: product does not degrade or cause a dangerous chemical reaction with the adsorbed liquid.
- One-sided spunbond gives extra strength as well as lower lint.
- Perforated for flexibility – tear at the perforations for smaller sized pads to use only what you need.

### Pads

Order Reference	Article No.	Description	Total Qty/Pack	Absorption Capacity (Ltrs)
UN100-E	813842	PADS, 41 cm x 51 cm, Medium weight, perforated & bonded	100 Pad(s) / Box	88
UN1212-E	813843	PAD, Medium weight, bonded 30 cm x 30 cm, 50 pads/Bag, 4 Bags/disp.box	200 Pad(s) / Dispenser Box	76

### Rolls

Order Reference	Article No.	Description	Total Qty/Pack	Absorption Capacity (Ltrs)
UN15-2DP-E	813844	ROLL, Medium weight, double perforated & bonded 38 cm x 46 m	2 Roll(s) / Box	147
UN15-DP-E	813845	ROLL, Medium weight, double perforated & bonded 38 cm x 46 m	1 Roll(s) / Dispenser box	73
UN15-DPS-E	813846	ROLL, Medium weight, double perforated & bonded 38 cm x 22 m	1 Roll(s) / Dispenser box	35
UN30-DP-E	813847	ROLL, Medium weight, double perforated & bonded 76 cm x 46 m	1 Roll(s) / Box	147
UN365-P	834177	ROLL, chemical absorbency, 19 cm x 15 m Perforated, 60 pads per roll	1 Roll(s) / Bag	12



### SPC - Sorbent Products

Your partner in helping your business guard against the leaks, drips and spills that create safety and environmental hazards in the workplace with quality sorbent products.

Contact your Brady Distributor to receive a copy of the SPC catalogue





## PIPEMARKERS

- This pipemarker dimension (12 x 150 mm) has been specially developed by Brady for the identification of small pipes.
- Ideal for marking Piped Medical Gases, these markers are made from thin, flexible polyester (B-7541)
- For Pipes with a diameter from 6 to 20mm
- Sold by the card, with 5 markers per card
- Many legends available - please visit [www.bradyeurope.com](http://www.bradyeurope.com) for full listing

Label Width A (mm)	Label Height B (mm)	Letter height (mm)	Total Qty/Pack
150.00	12.00	6.5	5 Marker(s) / Card



## SAFETY SIGNS ON ROLLS

- Material: Laminated Polyester
- Number of signs per roll: 250
- Available Sizes: Triangular with sides of 25, 50 or 100 mm
- Labels are supplied die-cut to a triangular shape



Width (mm)	W016	W023	W003	W009
25 mm	828682	829718	826758	827646
50 mm	828684	829720	826760	827648
100 mm	828686	829722	826762	827650



Contact your Brady Distributor to receive a copy of Brady's Pipe Marking and Safety Signs brochures.

Surfing [www.bradyeurope.com](http://www.bradyeurope.com) is a simple, efficient and timesaving way to learn more about BRADY products and applications, industry developments, events, promotions, etc. anytime, anywhere.

For looking up technical data sheets, downloading upgrades to your BRADY printers and software or fast registration of your BRADY products, there's just one address:

[www.bradyeurope.com](http://www.bradyeurope.com)



[www.bradyeurope.com](http://www.bradyeurope.com)

Brady offers a wide variety of custom solutions to fit your labeling needs. From printer guidance, to custom label parts, contact us to find out how Brady can help!

Find Brady on:



## CUSTOM SOLUTIONS AVAILABLE

Contact your local Brady office



### BRADY WHEN PERFORMANCE MATTERS MOST™

#### BRADY Africa

361 Olympic Duel,  
Northlands Business Park  
Newmarket Road  
Randburg  
Tel: +27 11 704 3295  
Fax: +27 86 501 7775

#### BRADY Benelux

Industriepark C/3  
Lindestraat 20  
9240 Zele, Belgium  
Tel. +32 (0)52 45 78 11  
Fax +32 (0)52 45 78 12

#### BRADY Central & Eastern Europe

Na Pántoch 18  
831 06 Bratislava, Slovakia  
Tel. +421 2 3300 4800  
Fax +421 2 3300 4801

#### BRADY Denmark

Svendborgvej 39D  
5260 Odense S  
Tel. +45 66 14 44 00  
Fax +45 66 14 44 50

#### BRADY France

Parc EURO CIT  
45, avenue de l'Europe  
59436 Roncq Cedex  
Tel. +33 (0) 3 20 76 94 48  
Fax +33 (0) 3 20 01 08 76

#### BRADY Germany

Brady-Straße 1  
63329 Egelsbach  
Tel. +49 (0) 6103 7598 660  
Fax +49 (0) 6103 7598 670

#### BRADY Hungary

Puskás Tivadar u. 4.  
2040 Budaörs  
Tel. +36 23 500 275  
Fax +36 23 500 276

#### BRADY Italy

Via Degli Abeti 44  
20064 Gorgonzola (MI)  
Tel: +39 02 26 00 00 22  
Fax: +39 02 25 75 351

#### BRADY Middle East FZE

PO BOX 18015  
Jebel Ali, Dubai, UAE  
Tel. +971 4881 2524  
Fax +971 4881 3183

#### BRADY Norway

Kjeller Vest 2  
2007 Kjeller  
Tel. +47 70 13 40 00  
Fax +47 70 13 40 01

#### BRADY Romania

World Trade Center  
Piata Montreal, nr 10  
Intrarea F, Etajul 1, Birou 1.16,  
Sector 1,  
Bucharest, 011469  
Tel: +40 21 202 3032  
Fax: +40 21 202 3100

#### BRADY Russia

"Chistye Prudy" Business Center,  
office 402  
Turgenevskaya Square, 2  
101000 Moscow  
Tel: +7 495 504 04 99

#### BRADY Spain & Portugal

Av. Ventisquero de la condesa 13,  
local 17 y 18  
28035 Madrid, Spain  
Tel. +34 900 902 993  
Fax +34 900 902 994

#### BRADY Sweden

Norgegatan 2  
164 32 Kista  
Tel. +46 (0) 8 590 057 30  
Fax +46 (0) 8 590 818 68

#### BRADY Turkey

Konaklar Mah. Selvili Sokak  
C13 Blok No.8 Kat:3 Daire:5  
34330 4.Levent-Besiktas  
Istanbul  
Tel. +90 212 264 02 20 / 264 02 21  
Fax +90 212 270 83 19

#### BRADY UK & Ireland

Wildmere Industrial Estate  
Banbury, Oxon – OX16 3JU, UK  
Tel. +44 (0) 1295 228 288  
Fax +44 (0) 1295 228 219

#### BRADY WORLDWIDE

Australia .....	612-8717-6300
Brazil .....	55-11-3686-4720
Canada .....	1-800-263-6179
China (Beijing) .....	86-10-6788-7799
China (Shanghai) .....	86-21-6886-3666
China (Wuxi) .....	86-510-528-2222
Hong Kong .....	852-2359-3149
Japan .....	81-45-461-3600
Korea .....	82-31-451-6600
Latin America .....	1-414-540-5560
Malaysia .....	60-4-646-2700
Mexico .....	525-399-6963
New Zealand .....	61-2-8717-2200
Philippines .....	63-2-658-2077
Singapore .....	65-6477-7261
Taiwan .....	886-3-327-7788
Thailand .....	66-2-793-9200
USA .....	1-800-537-8791

Your distributor

EUR-M-513-ENG 08/12/2016



Y1455478

© 2016 Brady Worldwide, Inc. All Rights Reserved.